

buki di tarea 8



Método pa siña lesa na Papiamentu



- breu
- sneu
- pareu
- flambeau

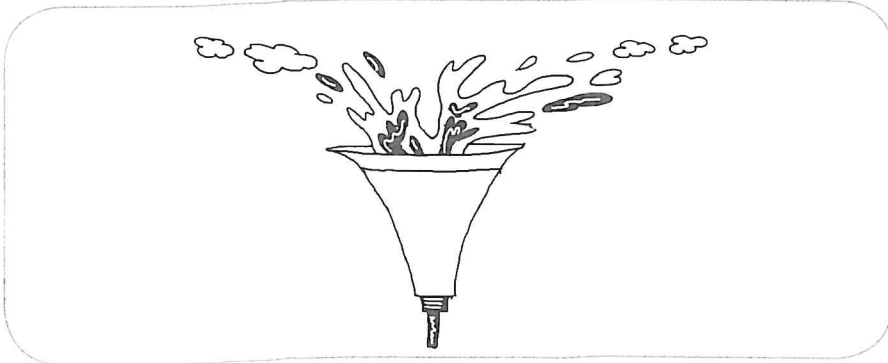

- leu
- pareu
- breu
- flambeau

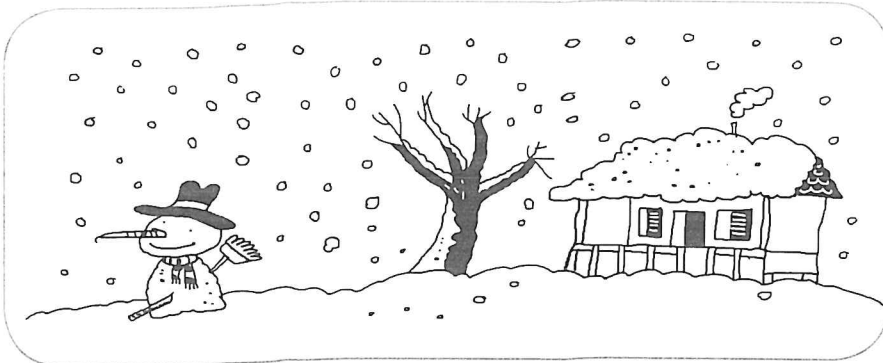

- sneu
- breu
- flambeau
- leu

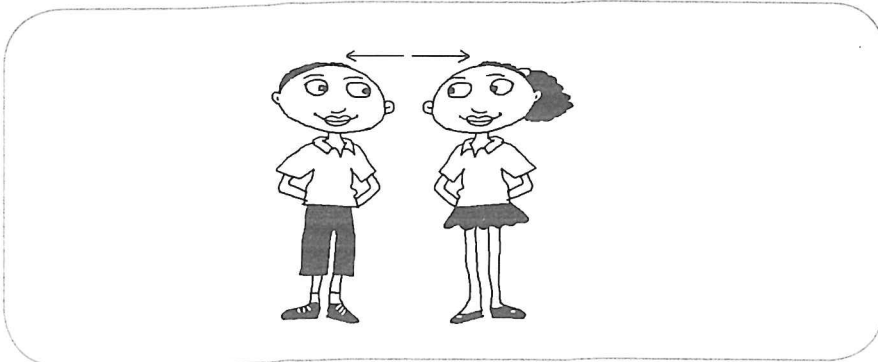

- sneu
- pareu
- flambeau
- breu

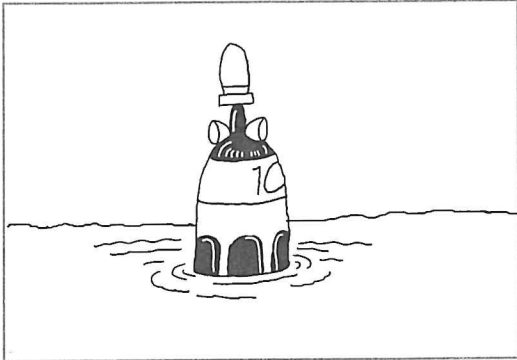

breu

leu

sneu

1. e bui no ta masha _____.



pareu

breu

leu

2. wak, riba dak tin _____.



sneu

pareu

flambeu

3. pam ta drumi den _____.

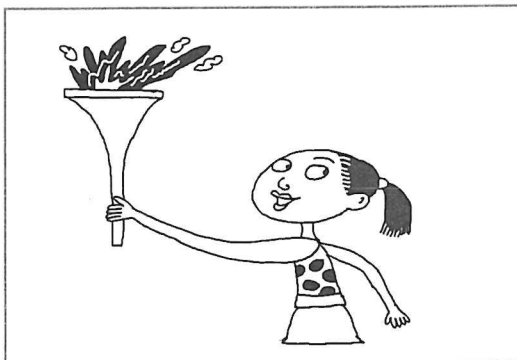

breu

flambeu

sneu

4. ani ta tene un _____.

ei eu oi ou

1. awe shon kòki tin mal b _____ s.

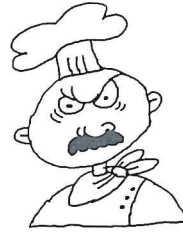

2. riba su frenta tin un pl _____.



3. e bolo den fòrnu no a r _____ s.

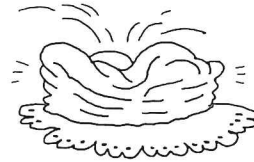

4. e sòpi di tomati ta keda l _____.



5. e karni kasi bo no por k _____.



6. salu ku peper kòki a war _____ a l _____.

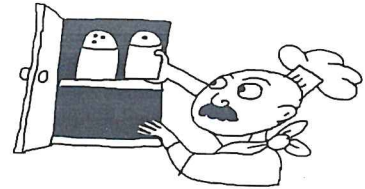

7. nos ta lanta for di mesa p _____ a r _____.



eu òf ei

br _____

batr _____

al _____

eu òf ou

bl _____

sn _____

trab _____

eu òf oi

par _____

mork _____

djal _____

eu òf ai

kab _____

flamb _____

tar _____

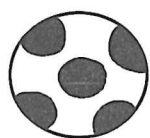

Shila Kamber

Shila a bai pasa dia.
na kas di nina.
tin un kamber bunita.
muraya tin poster.
n, ni dos, sino tres
er nèchi.

no tin poster,
ta pensa tristu.
ni muraya no tin pintura.
ni muraya no tin nada.
amber no ta bunita.

Shila yega kas
kohe papel,
pòtlot i leim.
pinta, e ta kòrta
leim.

ta traha un lora
pluma bèrdè i hel.

ta kla e
yega e lora na muraya.
nèchi bo kamber
kla, mama ta bisa.
ta hari, e ta felis.

Unda Shila ta awe?

- shila ta na kas.
- shila ta den su kamber.
- shila ta den kamber di nina.

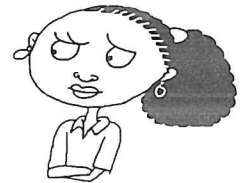
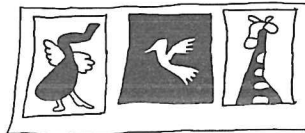

Kon e kamber di nina ta?

- na muraya no tin nada.
- na muraya tin tres poster.
- na muraya tin dos pintura.

Kiko shila ta hasi na kas?

- e ta pinta i kòrta.
- e ta pinta, kòrta i leim.
- e ta kòrta i leim.

Kon e lora di shila ta?

- e lora tin pluma.
- e lora tin pluma bèrdè.
- e lora tin pluma bèrdè i hel.

Dikon shila ta felis?

- shila su lora ta kla.
- shila su lora ta bunita.
- shila su kamber ta nèchi.





- stür
- püs
- skür
- zür



- yüni
- hür
- zür
- zürkol



- minüt
- skür
- püs
- hür

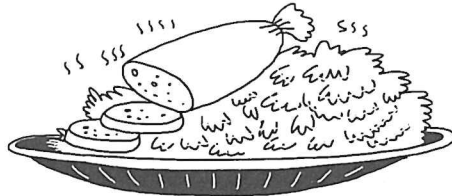

- stür
- minüt
- yüli
- zürkol



stür

skür

yüli

1. ta baiskel mi ta _____.

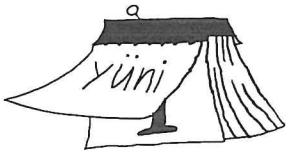

minüt

yüni

zür

2. mi ta hasi aña na _____.

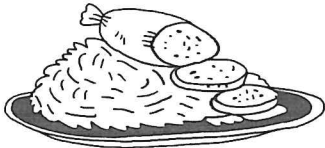

skür

hür

zürkei

3. mi gusta kome _____.

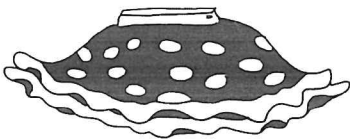

stür

püs

minüt

4. eva a haña un saya _____.

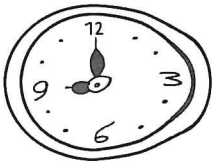

minüt

hür

skürkei

5. mi ta bini aki dies _____.



skür

hür

zürkei

6. e kashi ei tata a _____.

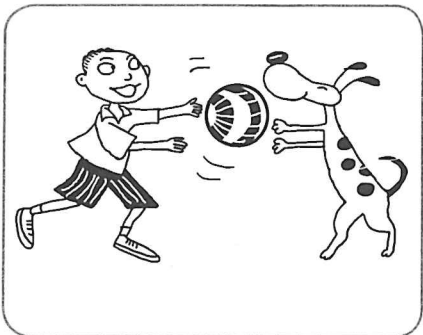
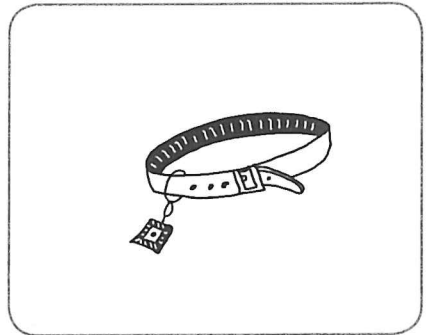
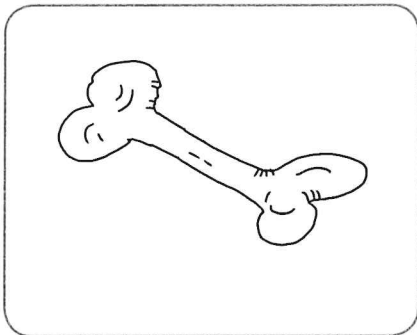
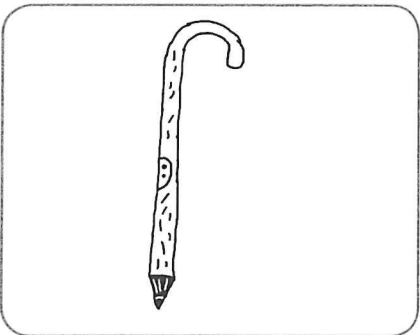
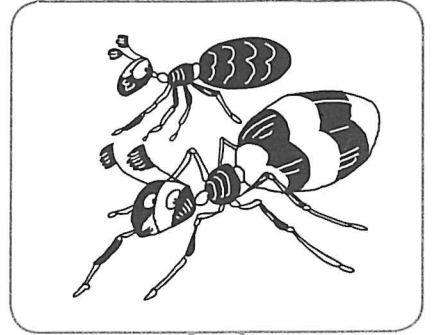
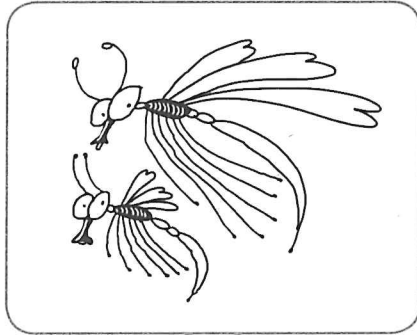

u ù ü

1. ora ta skur mi ta sende l _____ s.

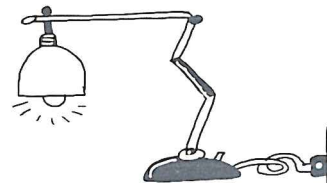

2. e b _____ s ta pasa ront.

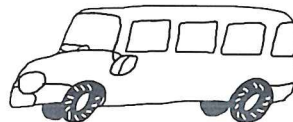

3. tata a h _____ r un kas di _____ wikènt.



4. e kashi ta hole m _____ f.

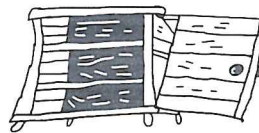

5. mi ta kome warm _____ s .

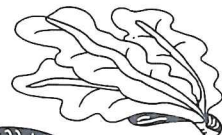

6. mi ta kla, warda mi un m _____ n _____ t.



7. mami ta hasi aña na y _____ ni.



8. bo ke s _____ ku den bo _____ e?



9. mi ruman ta siña st _____ r outo.



u òf ù

b _____ rt

s _____ t

pak _____ s

ù òf ü

z _____ r

tr _____ k

st _____ r

u òf ü

y _____ li

resk _____ k

min _____ t

eu òf u

par _____

air _____

flamb _____

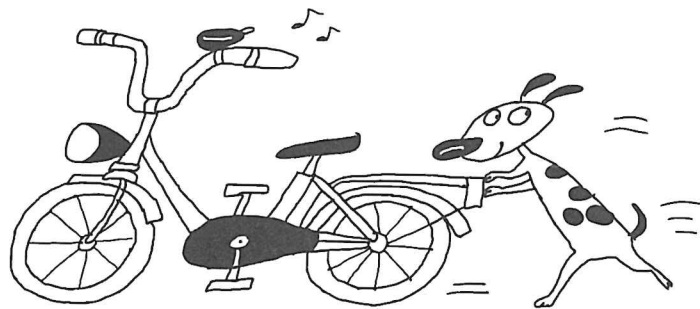

u eu ieu

1. mi wela ya ta b _____.



2. mi no ta biba l _____.



3. tata a kumpra un b _____ ki pa mi.

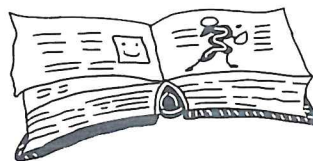

4. den su kabei tin p _____.

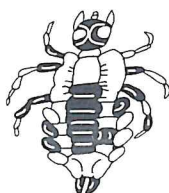

5. tito a spùit br _____ riba dak.



6. m _____ cha mester bebe lechi.



7. tata a sende e flamb _____.



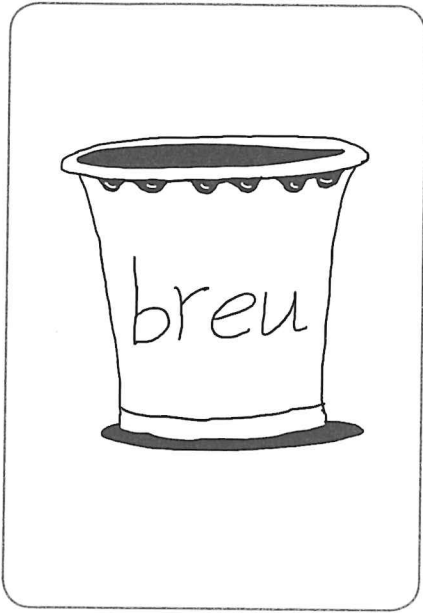

b _____

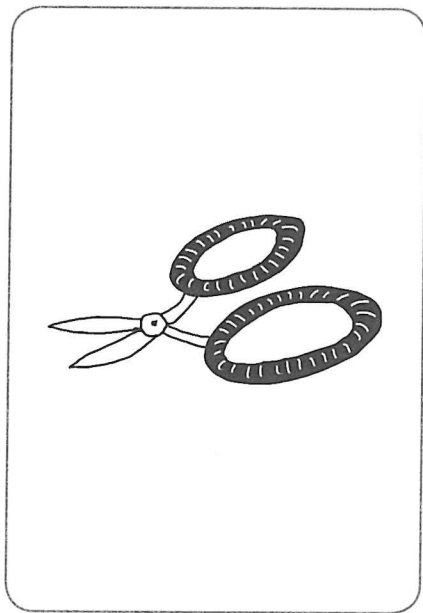

s _____



a _____

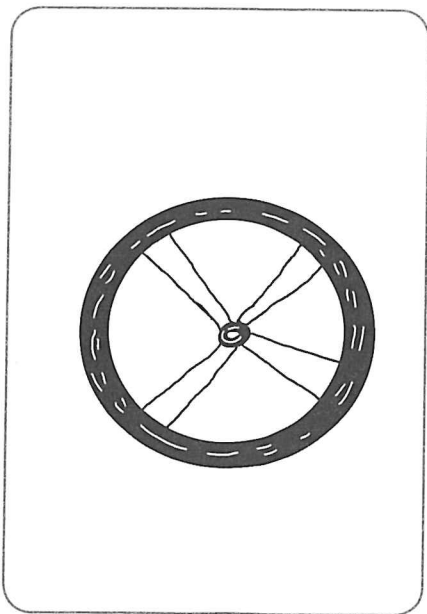

s _____

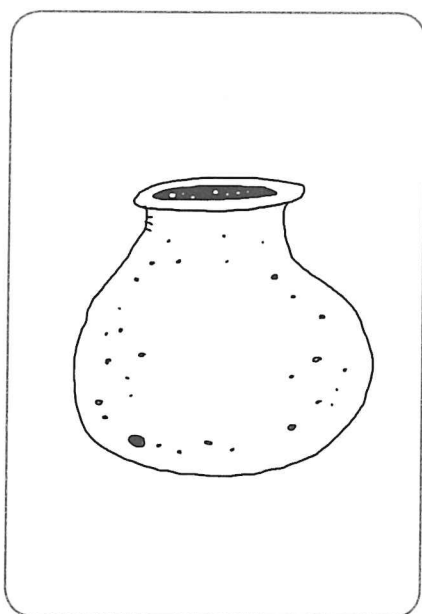

z _____

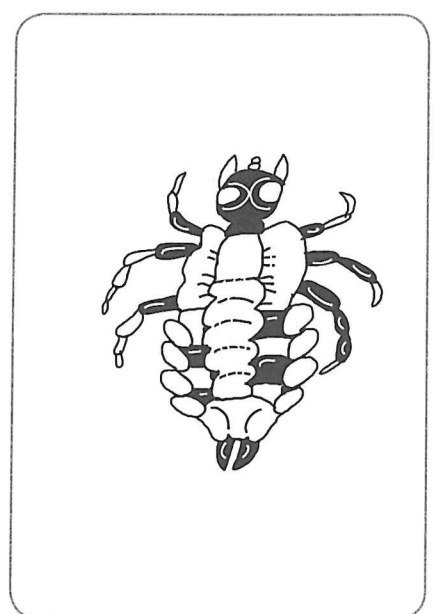

p _____

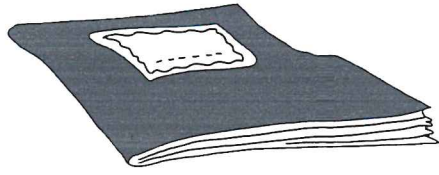

- straik
- sprin
- skref
- skruf

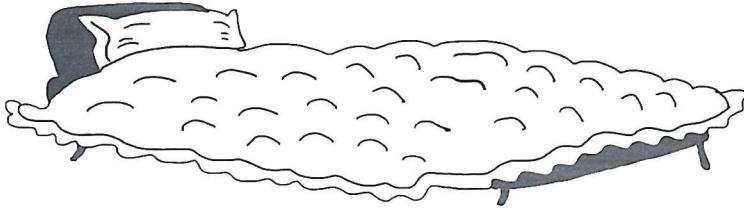

- straf
- skrap
- straf
- spreï

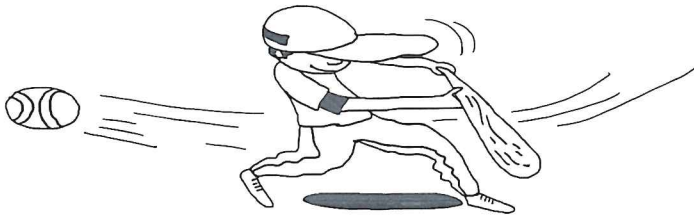

- skref
- straf
- straik
- sprin

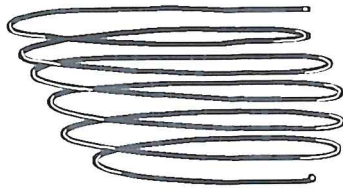

- streki
- sprin
- skrap
- spreï

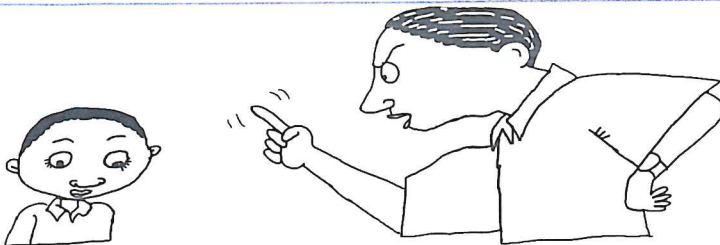

- straf
- sprin
- skruf
- spruït

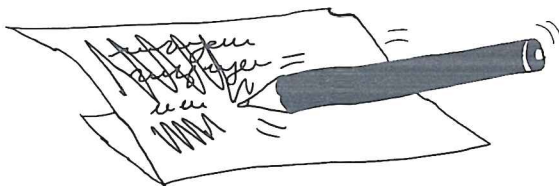

- stropi
- sprui
- skrap
- strika

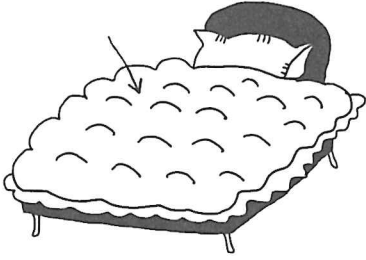

straik

sprei

skruf

1. riba mi kama tin un _____.

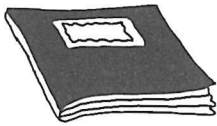

skref

strepì

sprui

2. mi ta skibi nèchi den m _____.



sprin

skruf

straik

3. wak, e picher a tira un _____.

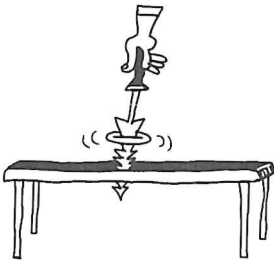

skruf

straf

sprùit

4. el a drecha e mesita ku _____.

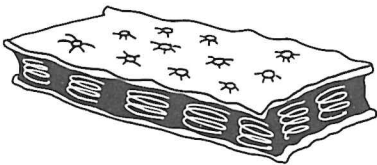

straik

sprin

skruf

5. mami ke un matras ku _____.



skref

streki

sprui

6. e payaso su yas tin un _____.

skr spr str

1. tata ta _____ uf e man di e stul pega.



2. ani ta _____ ika su shimis.



3. riba mi kama tin un _____ ei blou.

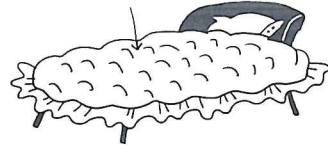

4. mi gusta _____ opi di tamarein.



5. áwaseru ta _____ engu.

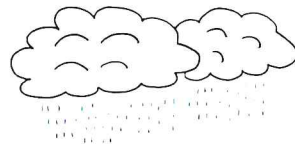

6. yùfrou a parti _____ ef nobo pa tur mucha.



7. for di e fòntein a sali un _____ al di awa.



8. mama ta _____ ui e mata.



str òf spr

_____ af

_____ eki

_____ ui

skr òf str

_____ ef

_____ año

_____ ùif

spr òf skr

_____ uf

_____ ap

_____ ichi

sp òf spr

_____ at

_____ in

_____ ada

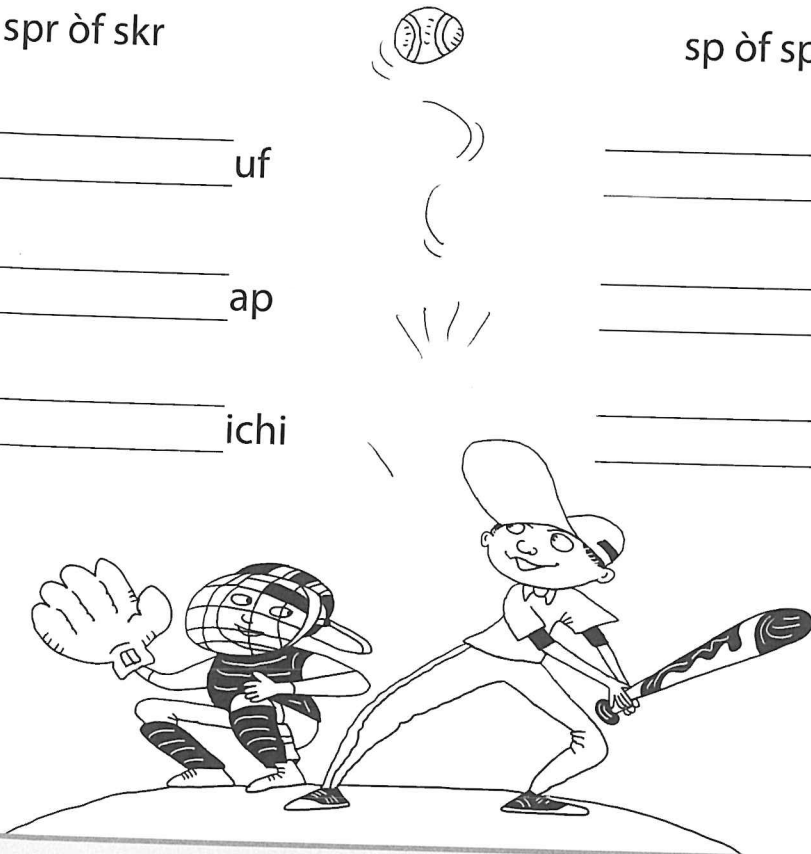

piki webu

'kimi,' mama ta bisa,
'bo por bai den kouchi di galiña?
bo por piki webu pa mi awe?'
mesora kimi ta bai.

den su man e tin un makutu.
un makutu pa e webunan.
'tòk, tòk, tòk,' e galiñan ta bisa
ora nan mira kimi.

den e kouchi no tin un, ni dos,
ni tres, sino seis webu.
pokopoko kimi ta pone nan
den su makutu.

kimi ta kana bai kushina.
e ta tene e makutu duru,
pa e webunan no kai.
den hardin ruman obi
ta hunga bala.
zuf ..., bum,
di ripiente e bala ta
dal den kimi su makutu.
e makutu ku webu ta kai.
tur webu ta kibra.
kimi ta yora.

kiko mami ta pidi kimi?

- kimi mester drecha su kama.
- kimi mester piki webu.
- kimi mester hasi respondi.

kiko kimi tin den su man?

- den su man e tin un baki.
- den su man e tin webu.
- den su man e tin un makutu.

kuantu webu tin den e kouchi?

- den e kouchi tin dos webu.
- den e kouchi tin tres webu.
- den e kouchi tin seis webu.

kiko ta pasa di ripiente?

- kimi ta spanta.
- un bala ta dal den e makutu.

dikon kimi ta yora?

- tur webu a kibra.
- e makutu a kibra.

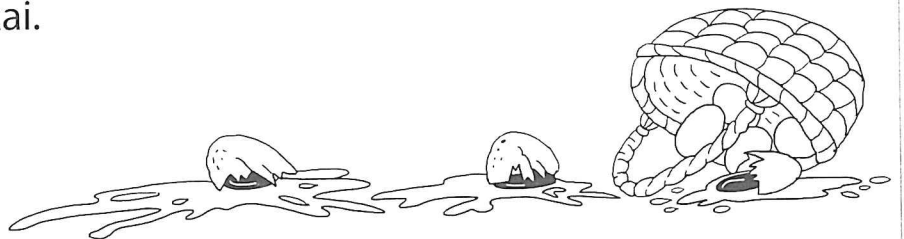



Kiki i e paranan

Kiki ta drumi den solo
ku un paña riba su kabes.
Sim i Zum ta yega serka.
'Kon ta, Kiki?' Sim ta wou.
'For di ki dia bo gusta
drumi den solo?
I pakiko bo tin un paña
riba bo kabes?'

Vups ... Kiki ta kita e paña.
'Yag mi ta yag,' e ta bisa.
'Ku un paña riba bo kabes?'
Zum ta puntra.
'Ui, esei sí mi ta haña straño.'

'Wak,' Kiki ta bisa,
'boso ta mira e buraku
den e paña?
Ora mi drumi ketu asina,
tur para ta kere ku mi
ta morto na soño.
Pero ta lur mi ta lur
den e buraku di e paña.
Ora un para yega serka,
mi ta bula lanta.'
'O, e pober paranan,' Sim ta wou.
'Sst,' keda ketu,' Kiki ta bisa,
'no reda mi,
sino tur para ta bula bai.'



F
f

- Yvòn
- Fani
- Obi



S
s

- Pepita
- Karla
- Sibel



I
i

- Isa
- Pina
- Viki



U
u

- Kèni
- Uri
- Yòrdi



K
k

- Wini
- Zena
- Kira



V
v

- Vera
- Zita
- Yara



O
o

- Omar
- Sam
- Udo



W
w

- Frank
- Wibo
- Ivo



Y
y

- Yuri
- Stèf
- Viktòr



P
p

- Sam
- Kurt
- Pablo



Z
z

- Olga
- Pòpi
- Zara

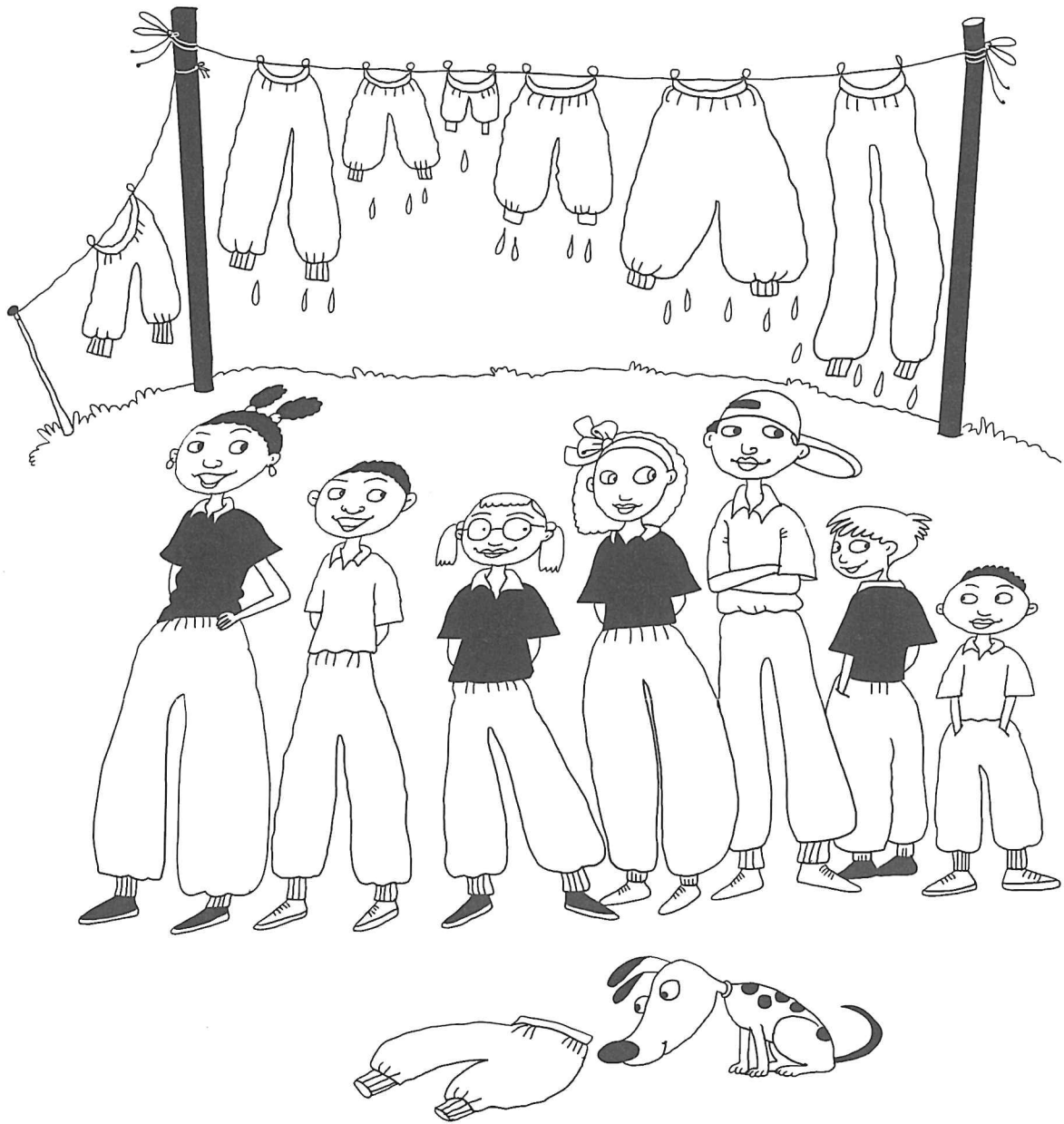

Un bishita spesial



Xandro, Juki i Carla
a bisti nèchi awe.
Juki tin un shimis ku
flor ros i un streki grandi.
Carla a bisti su saya nobo
i un blusa ku kanchi.
I Xandro a dal su dashi pushi
i su kamisa ku manga largu.

Kiko a pasa awe?
Xandro, Juki i Carla
ta bai na bishita
serka go-ber-na-dor.
Xandro, Juki i Carla
a haña un in-vi-ta-shon.

'Kòrda papia nèchi.
Ya boso ta mucha grandi kaba,
mami ku papi ta bisa
ora papi ta parker e outo
dilanti di e kas di go-ber-na-dor.

Un mener na unifòrm blanku
ta hiba nan serka go-ber-na-dor.
Xandro, Juki i Carla
ta haña li-mo-na-da i bolo.
Spesial pa go-ber-na-dor
nan ta kanta un kantika
ku nan a siña na skol.

Ora nan yega kas atrobe
Juki i Carla ta bisa:
'Papi ku mami, nos a pasa dushi.'
'Si,' Xandro tambe ta bisa.
'Ora mi bira grandi mi tambe ta
bira go-ber-na-dor.'

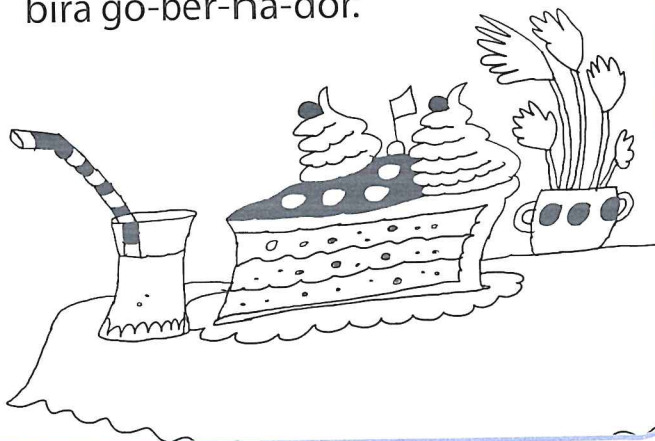



Carlo



Xenia

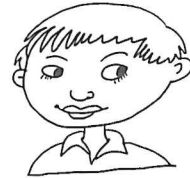

Jarik

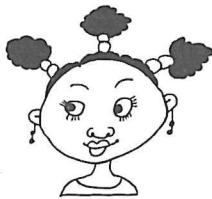

Jorina



Clarita



Xavi



Xeno



Jasmin

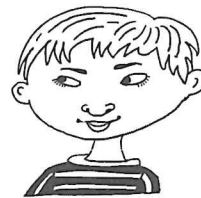

Camilo

C

J

X

Papi

Papi ta yuda mami awe.
Ya el a bari i stòf kas.
Pero ora papi ta bùk pa e
yena un hèmber ku awa,
su karson ta bisa kr...ak.

'Ui, tin asina un sker grandi
den papi su karson,'
Kurt ta bisa.
'Papi a bira muchu gordo,'
Jasmin ta tenta.

'Fui,' papi ta bisa,
'kon boso por bisa esei?'
Jasmin i Kurt ta wak otro
i nan ta grita hari.
'Papi tin ku hasi deporte,'
Jasmin ta bisa.
'pa e ba-ri-gon-chi bai.'
Papi no ta bisa nada mas.
Pero atardi ora solo baha
papi ta bisa di ripiente:
'Ken ke ban kana ku mi?'
Kurt i Jasmin ta bula lanta.
'Ye,' nan ta grita, 'nos papi
ta bai kana.
Papi su ba-ri-gon-chi ta bai!'

Kiko papi a hasi awe?

- Papi a stòf kas.
- Papi a yena un hèmber ku awa.
- Papi a stòf i bari kas.

Kiko Kurt ta bisa papi?

- Papi a bira muchu gordo.
- Papi a kome muchu kuki.
- Papi su karson tin un sker.



Dikon papi tin ku hasi deporte?

- Papi tin ku bai mas den aire fresku.
- Papi su ba-ri-gon-chi mester bai.
- Papi tin ku trein pa un kaminata.

Papi ta bai hasi algu?

- Nò, e ta keda wak tristu.
- Si, papi ta bai landa.
- Si, papi ta bai kana atardi.



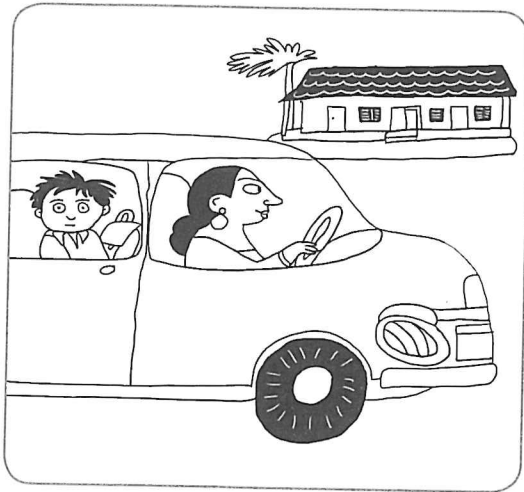

skol

outo

leu

Omar ta biba _____.

Su mama tin un _____,

pa e hiba Omar _____.

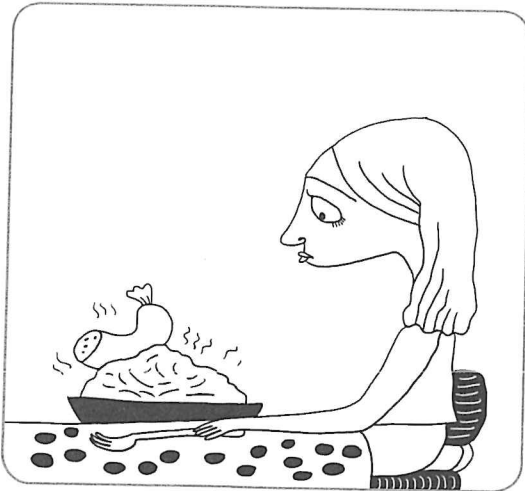

tristu

dia

zürkol

Sara no gusta kome _____.

Su kara ta _____.

Sara ke kome reskuk tur _____.

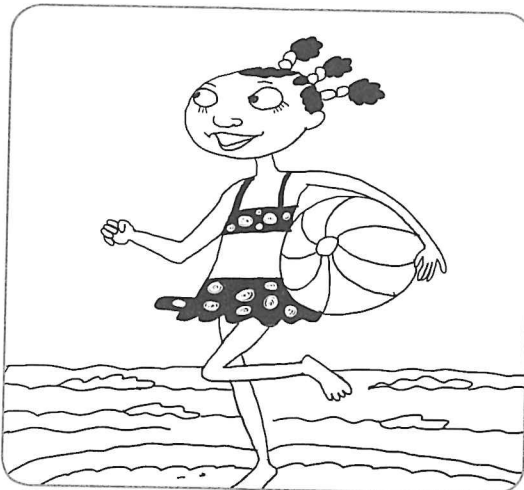

playa

landa

bikini

Vera ke _____.

Di wela e ta haña un _____,

Vera ta pasa dushi na _____.



E tim di futbòl

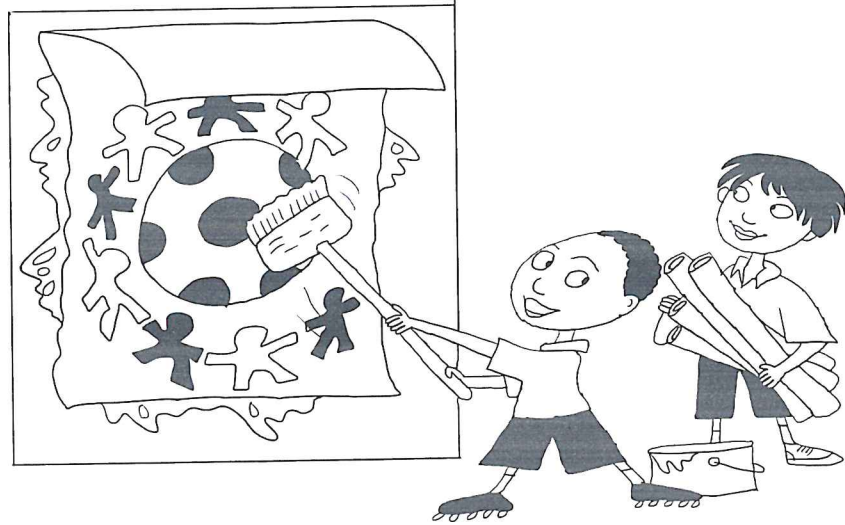

Arno ke lanta un tim di futbòl.
Tur su amigunan ta yuda.
Maik i Djòn ta traha un poster.
Riba e poster nan ta skibi:
Ken ke drehta nos tim di futbòl?
Lüdo ta pega e poster riba
bòrchi.
Awor un boka mester bisa otro.

Diferente mucha ke drehta
den e tim mesora.
Ròni ta traha un lista.
E ta skibi:
Bèni, Dik i Niko ke hunga bala.
Gèrt, Harwin i Ivo
tambe ke drehta tim.
Kurt ke bira kiper.

'Awor nos tin basta mucha
pa forma nos tim,' Arno ta bisa.
'Tin hasta un mucha ku mester
sinta riba banki di reserva.'

Tur djasabra e tim ta train riba
e vèlt di futbòl tras di misa.
Nan ta pasa dushi.
Nan ta pasa bon.
I ku nan lo gana tur
kompetensia
esei ta un kos ku ta sigur.



A
a

- Tini
- Ani
- Nina



B
b

- Brita
- Eva
- Jasmin



E
e

- Mita
- Dini
- Elvi

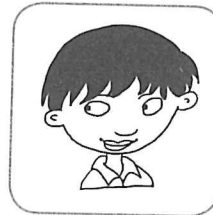

G
g

- Rèni
- Gil
- Tòm



H
h

- Hugo
- Levi
- Aròn



L
l

- Maya
- Dòna
- Linda



M
m

- Marisa
- Susi
- Gita

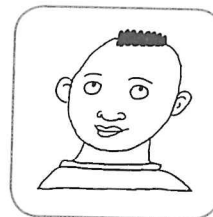

N
n

- Riki
- Wibo
- Niko



R
r

- Bèni
- Ròki
- Fifi



T
t

- Timo
- Stèf
- Yuri

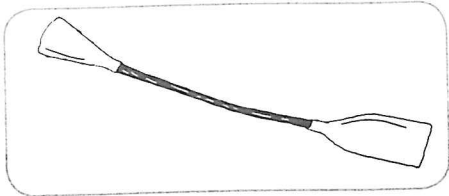
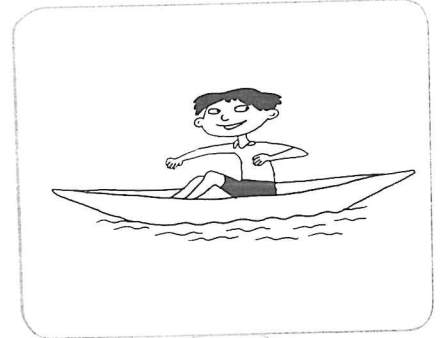
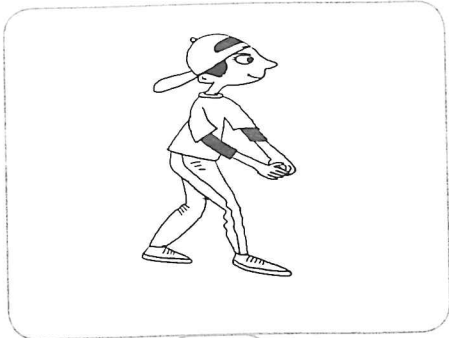
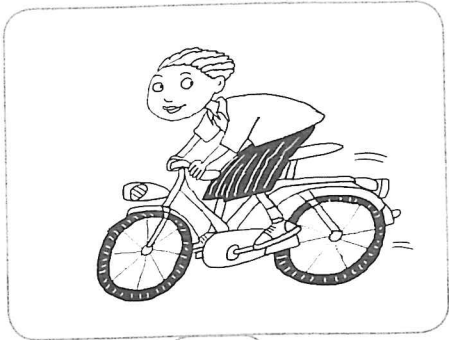

1

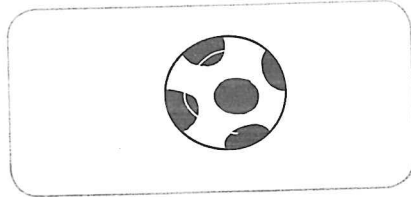

2

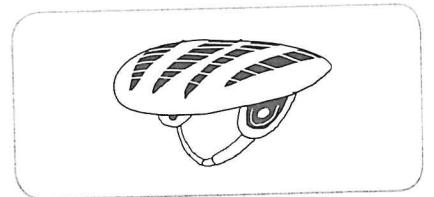

3

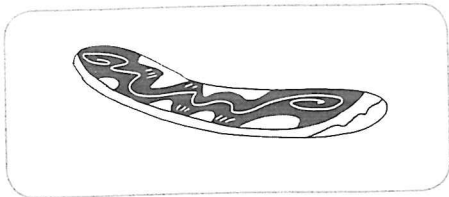

4

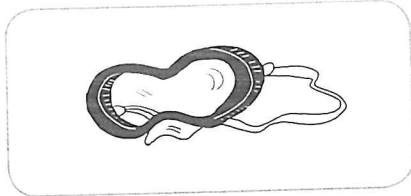

5

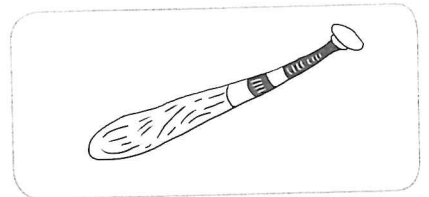

6

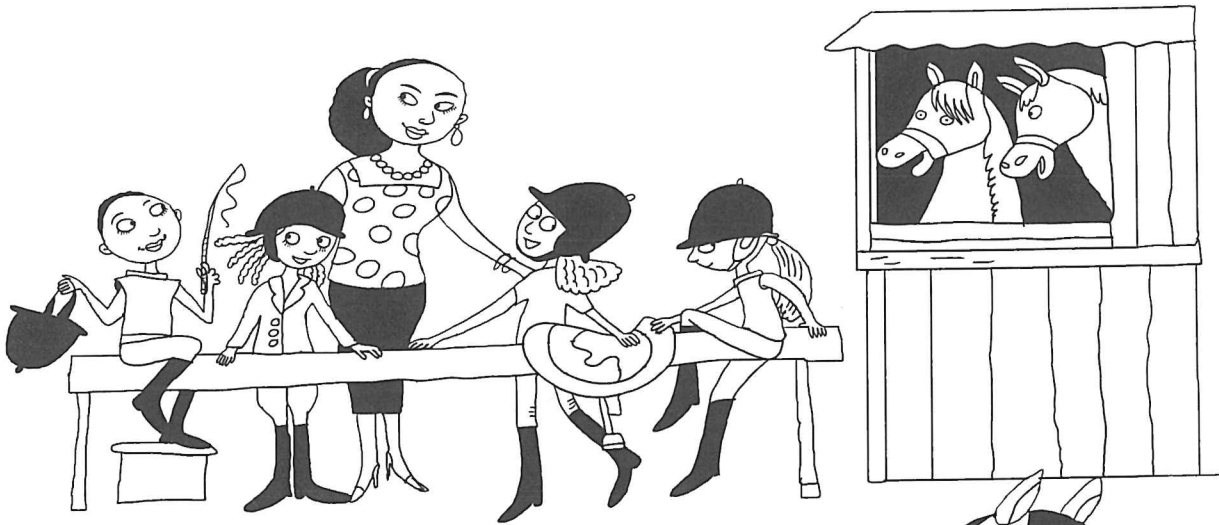

Kore kabai

Awe Qiona ku Brita ta bai skol di siña kore kabai. Mami ta hiba nan ku outo. E ta pasa buska Desi i Tòm. Qiona, Brita, Desi i Tòm ta siña kore kabai.

Na e skol di siña kore kabai nan ta topa ku amigu Qadir. Qadir ta kore un yewa pretu. 'Bo ke kore mi kabai awe, Qiona?' Qadir ta puntra. 'Si, Qadir,' esei ta bon idea,' Qiona ta bisa ku un kara kontentu. Kore kabai ta un deporte dushi!

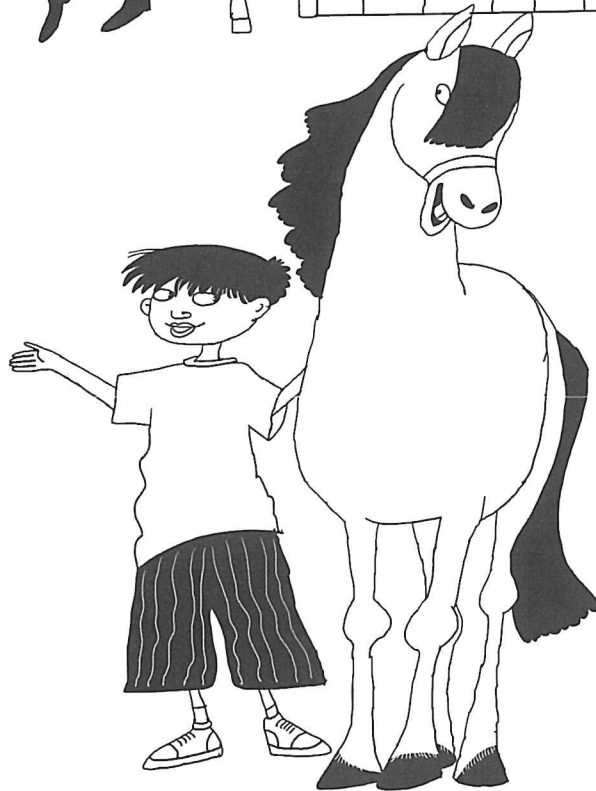



A _____

L _____

B _____

M _____

D _____

N _____

E _____

Q _____

G _____

R _____

H _____

T _____

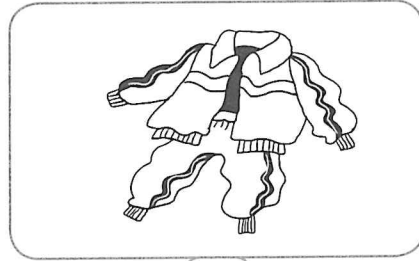
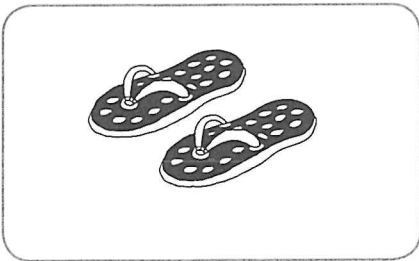
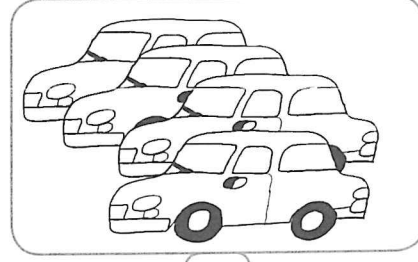
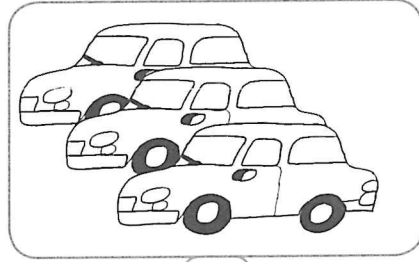
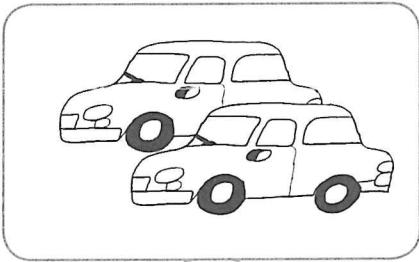
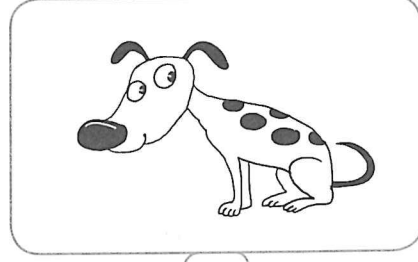
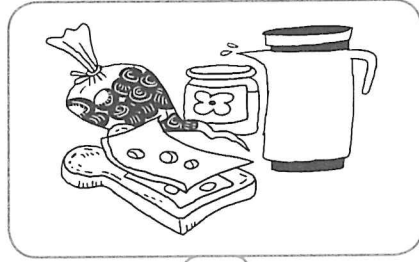
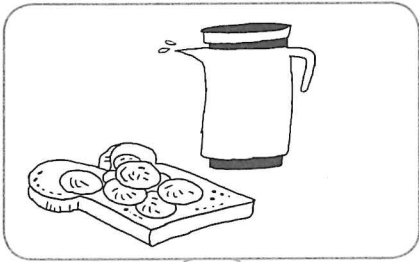
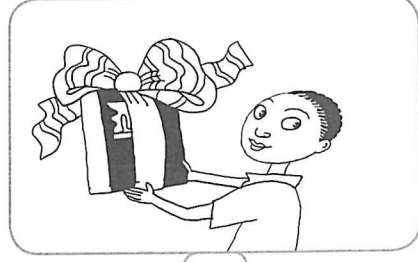
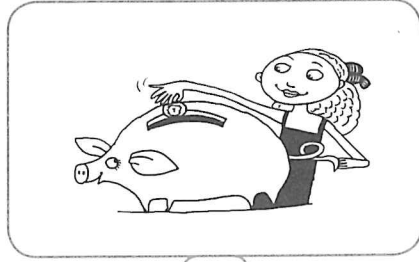

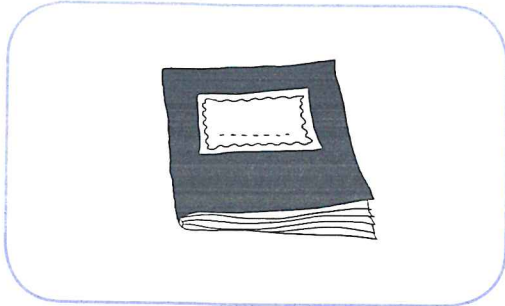

- skref
- stref

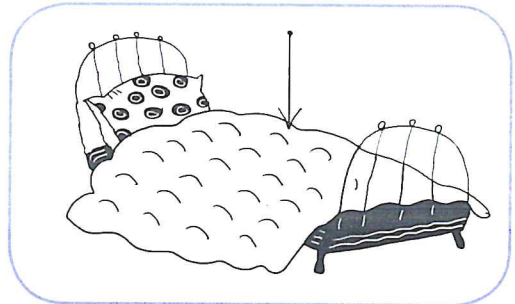

- strei
- spreii

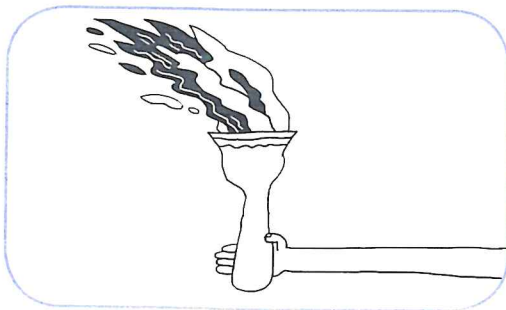

- flambeu
- flambei



- stropi
- skropi

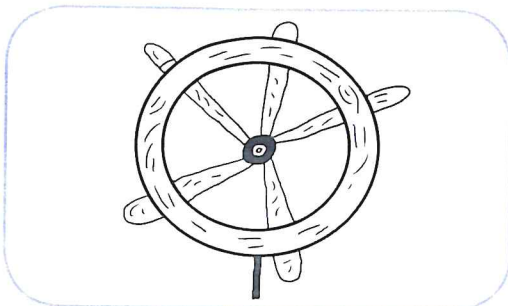

- stur
- stür



- zür
- zur

A
a

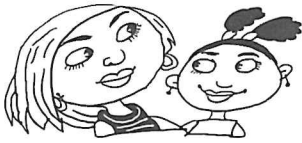

Mama Ada ku _____

B
b

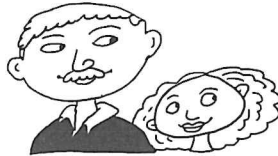

Tata Bèrt ku _____

D
d



Tata Dik ku _____

E
e



Mama Eva ku _____

F
f



Tata Fòns ku _____

G
g

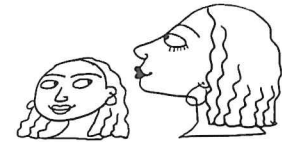

Mama Gèrda ku _____

H
h

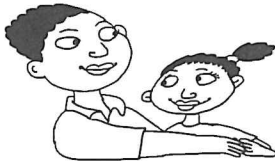

Tata Hugo ku _____

L
l

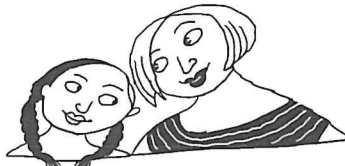

Mama Lis ku _____

M
m



Mama Mita ku _____

N
n

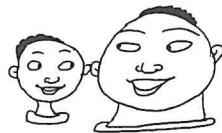

Tata Nabil ku _____

Q
q



Tata Qahir ku _____

R
r



Mama Rosi ku _____

T
t



Mama Tina ku _____

Y
y

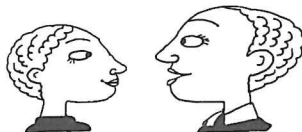

Tata Yasir ku _____

Z
z

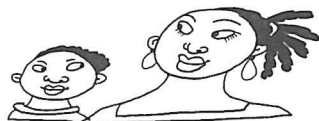

Mama Zita ku _____

Belinda
Dagmar
Filip
Qiona
Yuri

Ròbi
Zeno
Alina
Nasim
Maik

Tòm
Lara
Greta
Elina
Hana

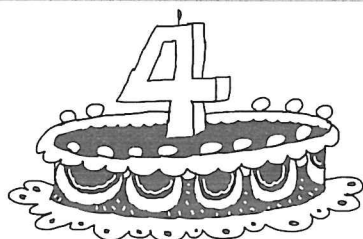

- duars
- kuashi
- suak
- kuater

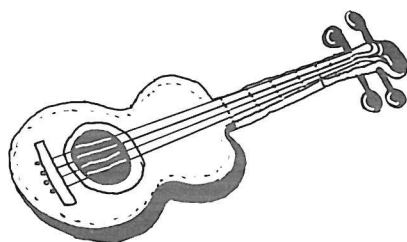

- sua
- duars
- kuarta
- kuart



- quadro
- kuarto
- suave
- kuarteto



- kuater
- suafel
- sua
- suak



- quadro
- kuashi
- kuarteto
- kuater

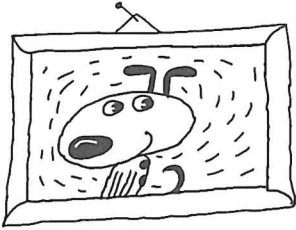

kuart

kuater

kuadro

1. Mami tin un _____.



suak

kuashi

suafel

2. Pai ta fèrf ku un _____.

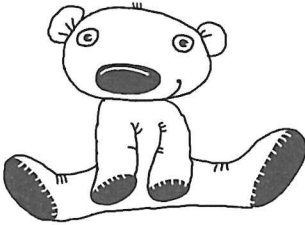

suave

sua

suafel

3. Mi ber pelucho ta _____.



kuarteto

kuadro

suak

4. Ken ke hunga _____?



kuarta

kuarto

kuater

5. Mi ke siña toka _____.

ua eu ui ùi

1. Tawela a duna mi un k_____rta.

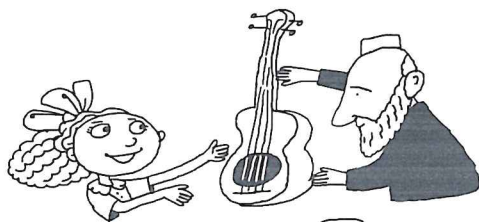

2. Mi ruman hòmber a haña un fl_____t.

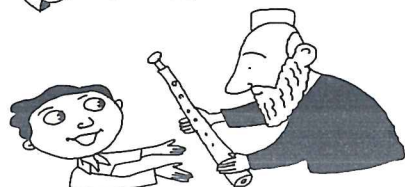

3. Huntu nos ta toka den mi k_____rto.



4. Nos ta start toka par_____.



5. Mami ta spr_____e flornan den hardin.



6. E ta hisa su d_____m.



7. El a skucha nos toka djal_____.



ua òf ùi

s _____ ve

sp _____ t

s _____ k

ua òf ou

s _____ s

k _____ rta

d _____ rs

ua òf eu

s _____

djal _____

par _____

ua òf ui

k _____ shi

spr _____

k _____ rteto

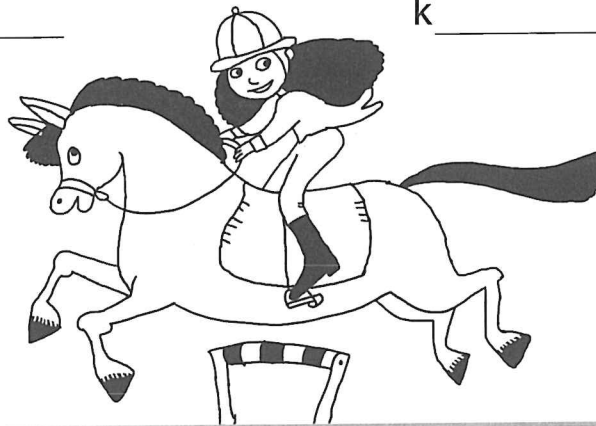

Dia di deporte

Ta seis or.

Wèker ta rin.

Erik ta lanta for di soño.

E no tin gana di bai skol awe.

E tin gana di keda den kama.

Mama ta drenta.

'Lanta Erik,' mama ta bisa.

'Bo tin ku bai baña.'

'Mi ta sinti malu, mami,'

Erik ta keha.

'Mi barika ta morde.'

Dikon Erik ke keda den kama?

Ta muchu trempan.

Awe no tin skol.

Erik no tin gana di bai skol.

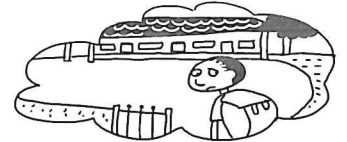

Kiko Erik ta bisa mama?

Mi no tin gana di lanta.

Mi no ke bai skol awe.

Mi barika ta morde.



'Wèl, e ora ei bo

tin ku keda den kama,'

mama ta bisa.

Mi lo yama skol

pa bisa ku bo ta malu.'

Mama ta kana bai.

Pero di ripiente Erik ta kòrda

ku awe ta dia di deporte.

Mesora e ta bula lanta.

'Mami,' e ta bisa, 'mi

barika no ta morde mas.'

'O,' mama ta bisa, 'esei sí

ta un mirakel.'

Of ta kòrda bo a kòrda ku

awe ta dia di deporte na skol?'

Ta ken mama ke bai yama?

Mama ke yama dòkter.

Mama ke yama skol.

Mama ke yama wela.



Dikon Erik ta bula lanta tòg?

E ta kòrda ku ta dia di deporte.

Mama ta bisa ku e mester lanta.

E no tin gana di keda drumi.





- patio
- radio
- sabio
- video

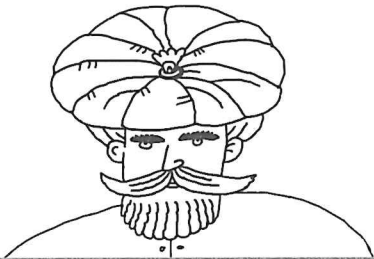

- premio
- indio
- bario
- kambio

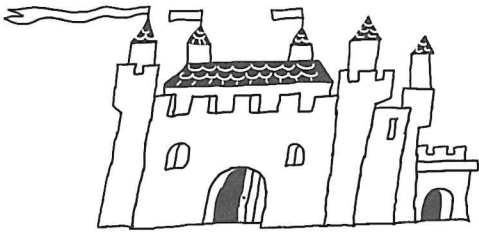

- palasio
- serio
- podio
- akuario



- sitio
- video
- premio
- propio

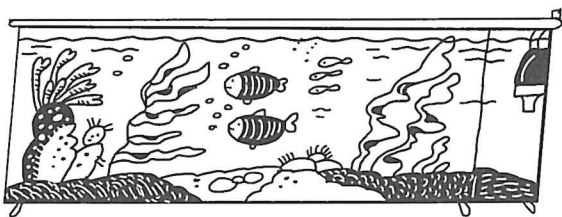

- genio
- serio
- akuario
- bario



bario

premio

serio

1. E muchanan a gana un _____.



sabio

kambio

bario

2. Tin un vèlt den nos _____.



palasio

akuario

vidio

3. E reina ta biba den un _____.

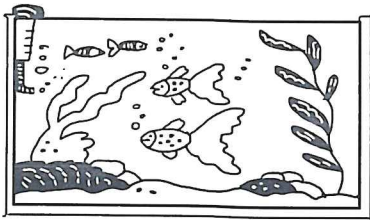

akuario

premio

podio

4. Bo no por landa den un _____.

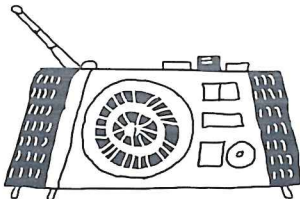

sitio

radio

alivio

5. Mi gusta skucha _____.



Hasi at-le-tis-mo

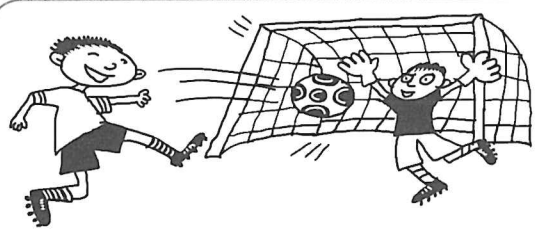

Hunga futbòl

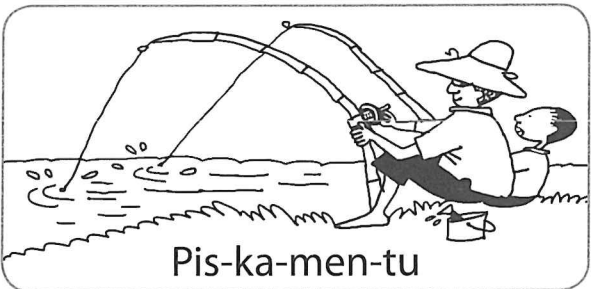

Pis-ka-men-tu

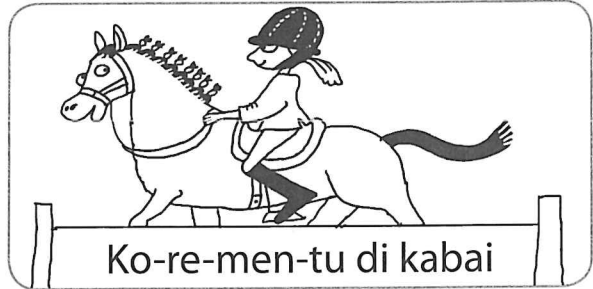

Ko-re-men-tu di kabai

as, bala, bula, flùit, gol, hak, kabai, kèp, kore, liña, sia, tira

ieu io oi ua

1. Shon Toni ta hopi b_____.



2. Su kara ta yen di pl_____.



3. Pero e sa mas ku tur hende den bar_____.



4. Shon Toni ta un sab_____.



5. Bo no mester wak vid_____ ni dvd.

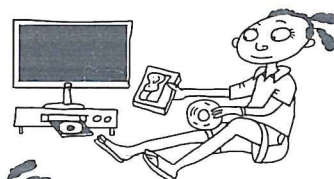

6. Ni bo mester skucha rad_____.



7. Si bo ke sa k_____ lke kos, shon Toni por yuda bo.



io òf oi

rad _____

pl _____

bar _____

io òf oi

ser _____

mork _____

ind _____

io òf ei

kab _____

batr _____

sab _____

io òf ou

infr _____

prem _____

palas _____

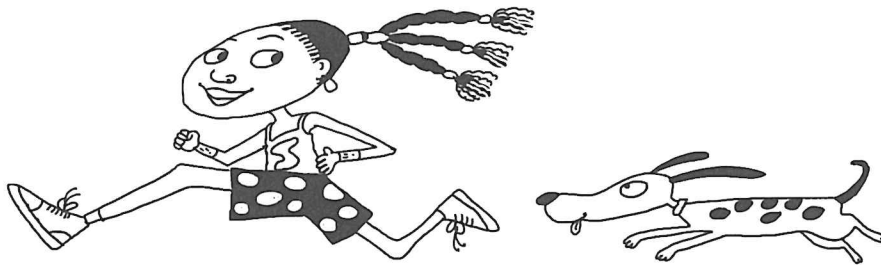

ua ou uai iou

1. Mami ta baha for di su _____ to.



2. Den su mannan e tin k _____ ter saku.



3. Bisiña ta z _____ i e ta bisa:
'Kon ta bai?'

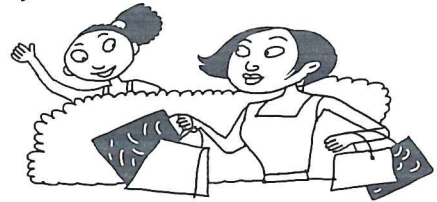

4. 'M _____ ; Kiki tambe ta bisa.

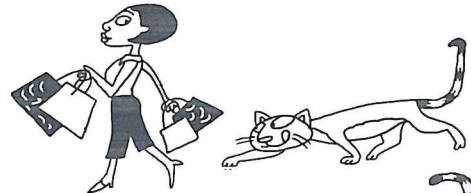

5. 'K _____ sorpresa tin den e sakunan?'

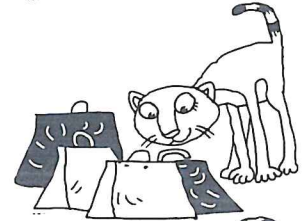

6. Sim ta waya su rabu.
Den saku tin kos dushi?' e ta w _____.



7. Mami ta hari i e ta bisa:

'Bak _____ pa Kiki i un wesu pa Sim.'

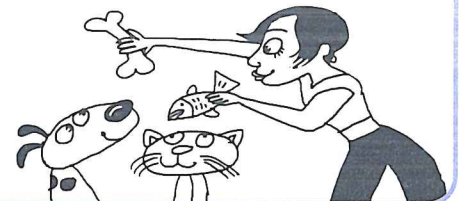

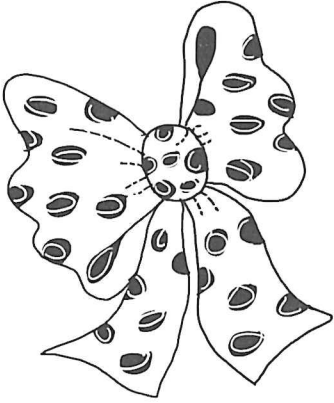

s



b

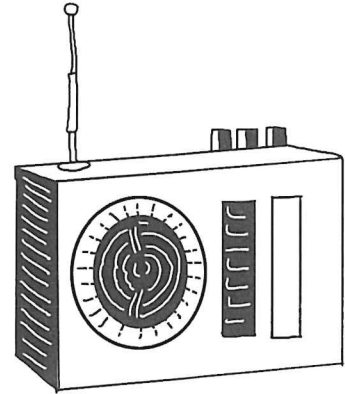

r



k

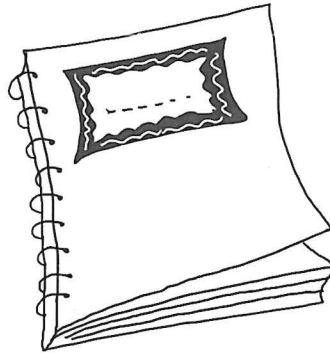

s



z

Fruta

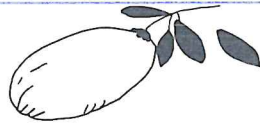

Dini ta den hòfi.
E ta drumi den hamaka.
Den hamaka bou di palu di mango.
E hamaka ta zoya bai bin.

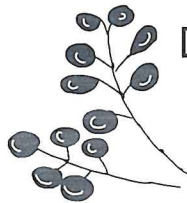

Sòni ta sinta bou di palu di shi-ma-ru-ku.
Banda di e palu tin un taki ku ta rama riba tera.
Sòni ta mira asina pampuna grandi na e taki.

Bou di ki palu Dini ta drumi?

- E ta drumi bou di palu di mospel.
- E ta drumi bou di palu di shi-ma-ru-ku.
- E ta drumi bou di palu di mango.

Kiko Sòni ta mira na e taki?

- Sòni ta mira mango.
- Sòni ta mira algun blachi.
- Sòni ta mira pampuna grandi.

'Dini,' Sòni ta bisa,
'bo no ta haña straño
ku tin fruta ta krese
na palu i otro fruta
ta krese na taki ku
ta rama riba tera?'

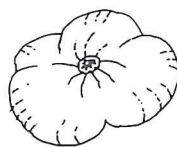

Sòni no a kaba di papia
òf un shi-ma-ru-ku ta kai
riba su kabes.
'Ha, ha,' Dini ta hari.
'Bo ta mira awor ku ta
bon ku pampuna no ta krese na
palu?

Unda tin fruta ta krese?

- Tin fruta ta krese na palu.
- Tin fruta ta krese na taki ku ta rama.
- Tin fruta ta krese na palu i taki ku ta rama.

Ta kiko Dini ta bisa Sòni?

- Ta bon ku no ta pampuna ta krese na palu.
- Un pampuna por kai riba bo kabes.
- Shi-ma-ru-ku no por krese na taki ku ta rama riba tera.

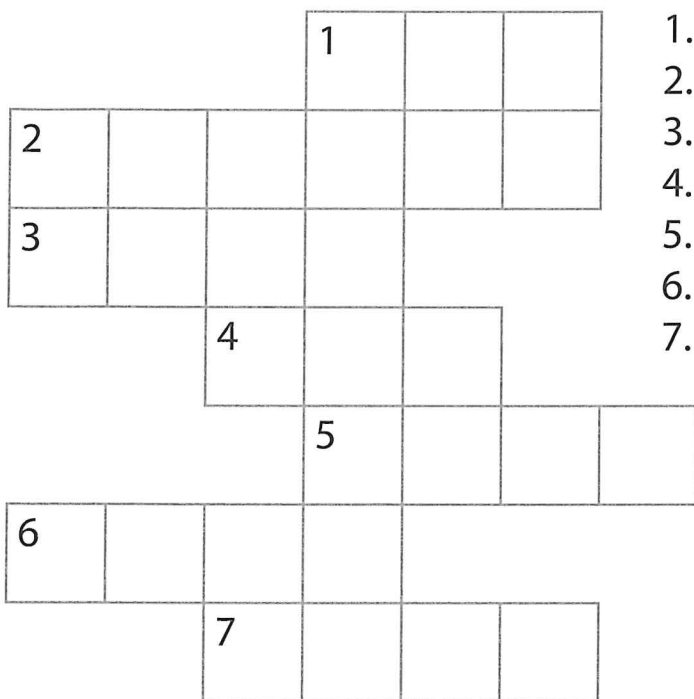

1. E tim ta d... bala duru.
2. E a... ta bula haltu.
3. E siklista a bora su c...
4. E kiper ta para den g...
5. Ku un r.. e boto bai dilanti.
6. E tim ta trein riba v...
7. Bientu ta bòl e b... riba laman

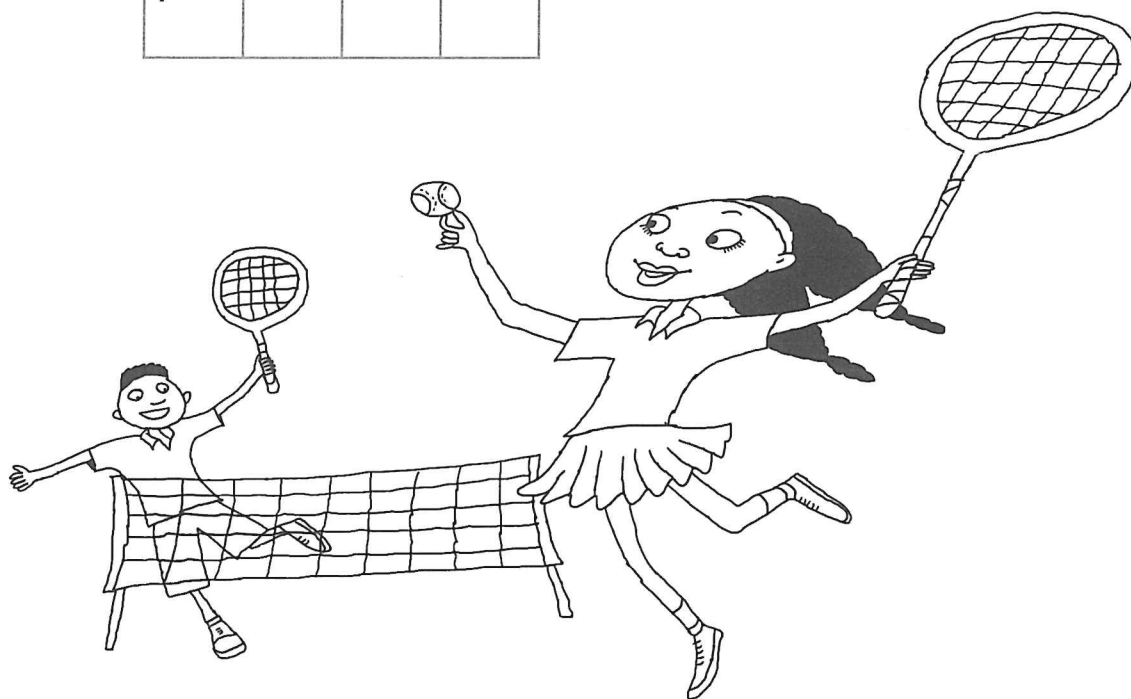



- riu
- friu
- hudiu
- skiu



- palufriu
- skiu
- riu
- hudiu

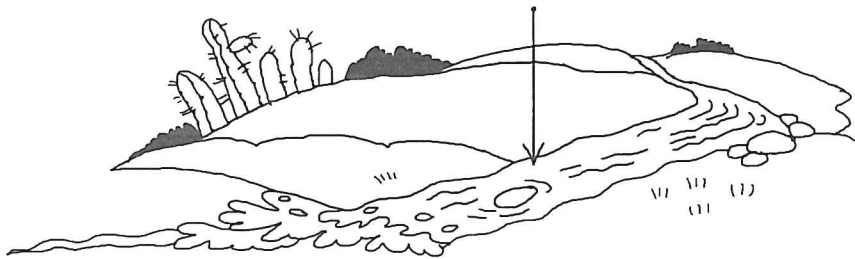

- kalafriu
- friu
- riu
- skiu

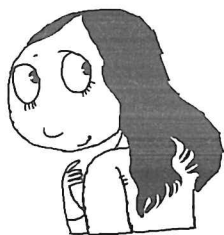

- skiu
- friu
- riu
- palufriu



- riu
- friu
- palufriu
- skiu



skiu

friu

hudiu

1. Amigu Levi ta _____.



friu

palufriu

kalafriu

2. Arla ta lembe su _____.

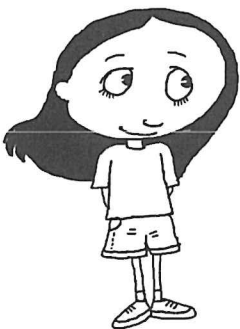

skiu

hudiu

kalafriu

3. Eva ta un tiki _____.



hudiu

skiu

friu

4. Sim di: ' Mi tin _____!

ai

eu

iu

ùi

ua

iou

1. Awaseru a k _____ duru.



2. Awor tin manera un r _____ di awa
ta kore den hardin.

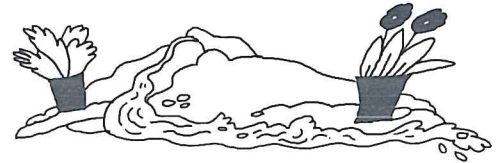

3. Blenchi, mòfi i chuchubi ta fl _____ t.
Nan ta felis.



4. Nan ta tuma un baño den e awa fr _____.

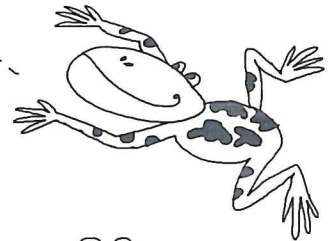

5. Shon sapu tambe ta b _____ landa.

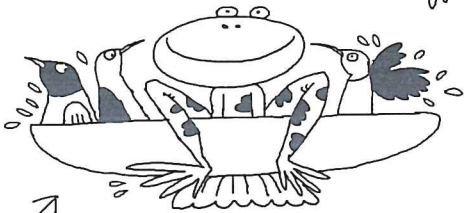

6. Awor nan ta ku nan k _____ ter den awa.



7. 'M _____,' Kiki ta bisa .

8. Pushi no gusta awa,
ami sí ta keda l _____.



iu òf ui

b _____

sn _____

fr _____

iu òf ua

k _____

r _____

s _____

iu òf ùi

fl _____ t

kalafr _____

br _____ t

iu òf oi

mork _____

hud _____

palufr _____

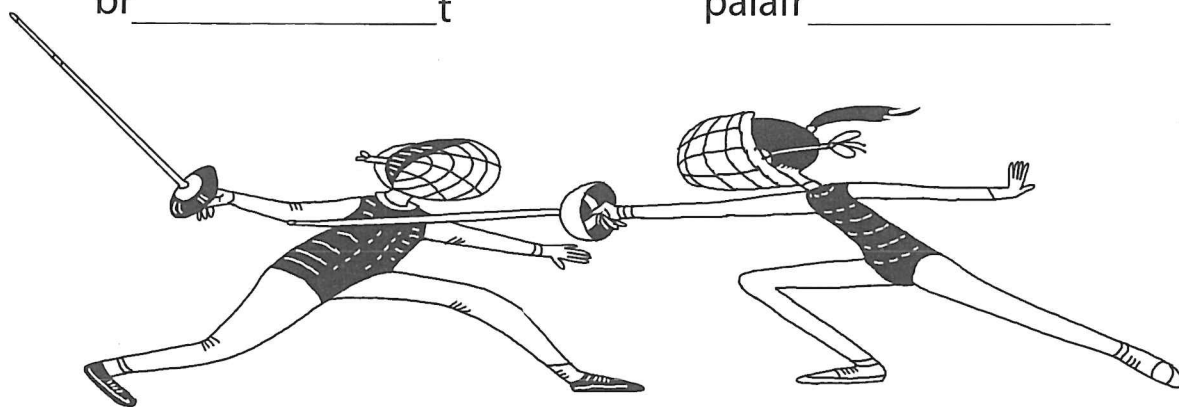

E kas di Tòm

Tòm ta traha un kas.

E ta traha un kas den palu di tamarein.

Bam, bam, bam, su martin ta zona.

Pokopoko e kas ta bini kla.

Tòm ta fèrf su kas.

E dak ta bira bèrdè

i e murayanan Tòm ta fèrf blanku.

Riba su kas ta bin un bandera.

Den ki palu Tòm ta traha un kas?

Den palu di mospel

Den palu di tamarein

Den palu di mango



Kua koló Tòm a fèrf e kas?

E kas ta blanku.

E kas ta blanku ku bèrdè.

E murayanan ta blanku i e dak ta bèrdè.

Banda di seis or

e kas di Tòm ta tur kla.

Mitar di nuebe e ta subi kama.

Tòm ta pega soño mesora.

Pero meimei di anochi awa ta kai i

bientu ta supla duru.

E dak di e kas den palu

ta bula bai.

Ora Tòm lanta for di soño

su kas no tin dak mas.

'No yora, Tòm,' tata ta bisa.

Ora mi yega kas for di trabou,

mi ta bai yuda bo.

Nos ta bai traha un dak nobo.

Un dak ku no ta bula bai

nunka mas.

Kuant'or Tòm ta bai drumi?

Tòm ta bai drumi seis or.

Tòm ta bai drumi mitar di nuebe.

Tòm ta bai drumi nueb'or.

Dikon e kas di Tòm no tin dak mas?

Pasobra bientu a supla.

Pasobra bientu a supla duru.

Pasobra awa a kai.

Kiko tata ta bisa Tòm?

Nos ta bai traha un dak nobo.

Nos ta bai drecha e dak.

Nos ta bai traha un dak nobo ku no ta bula bai nunka mas.

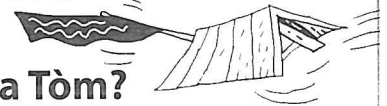



f



z

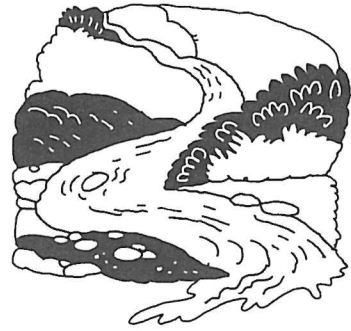

r



b

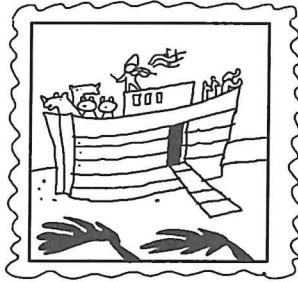

k



un mucha h

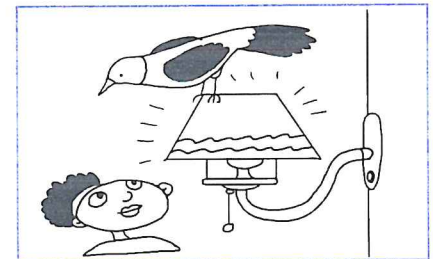
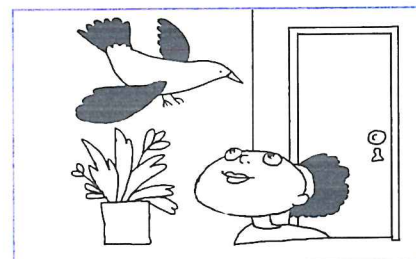
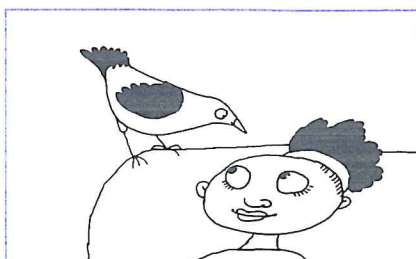
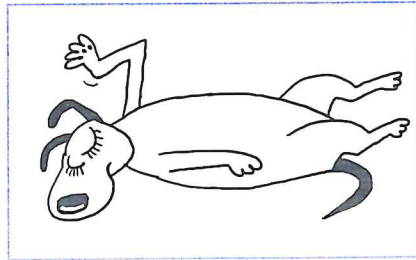
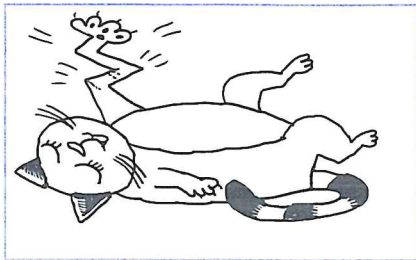

eu

ieu

iou

iu

str

ü

ua

1. Mi ruman a hasi k_____ter añã.



2. Pushi gusta kome bak_____.



3. E stul b_____a kibra.



4. E shimis tin un _____eki blou grandi.



5. Luna ta hopi l_____.



6. Den èrko ta fr_____.



7. Tata ta yega kas aki sinku min_____t.





Método pa siña lesa na Papiamentu

buki di tarea 8

Tim di outor

**Ronnie Severing • Ria Severing-Halman
Mavis Ersilia • Marelva Mathilda
Sharine Juliana • Ange Jessurun**

Ilustrashon

Anjo Mutsaars

Realisashon

Paul Dijkstra, Wietske Dijkstra

Salto, Buki di tarea 8
ISBN: 978-99904-2-253-5

© 2010 Fundashon pa Planifikashon di Idioma
Derecho reservá. No ta pèrmití pa reproducí nada di e edishon akí di ningun
forma, ni pa ningun medio, sin outorisashon previo i skibí di editor.



Fundashon pa
Planifikashon di
Idioma