

# buki di tarea 5

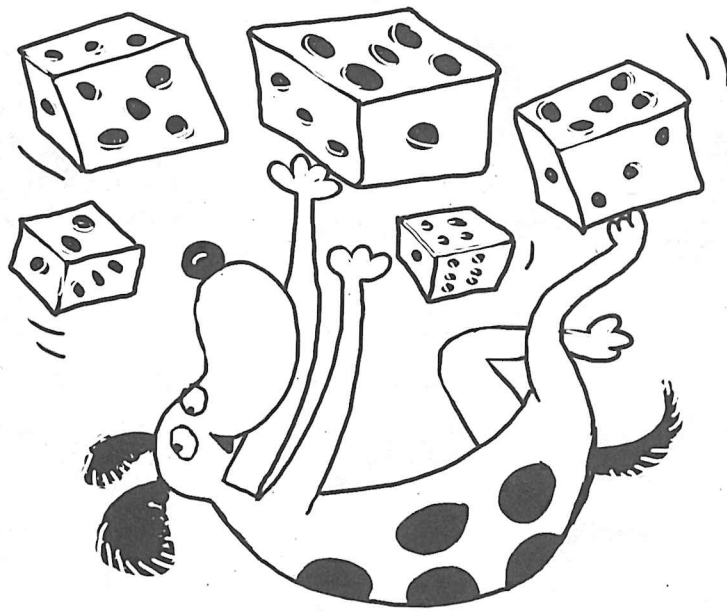

Método pa siña lesa na Papiamentu

dou

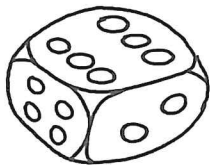

dou

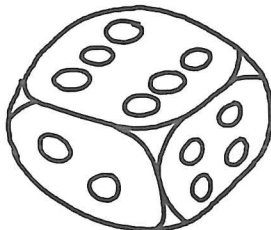

kou

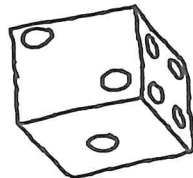

dou

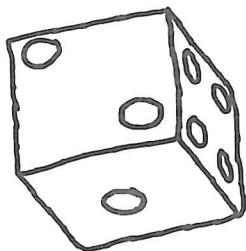

bou

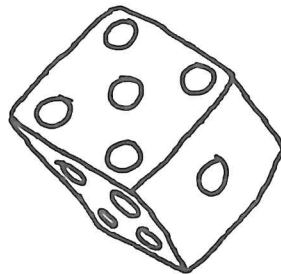
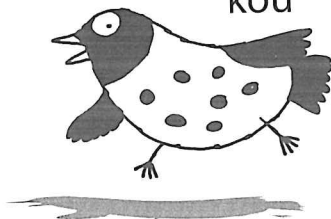

do

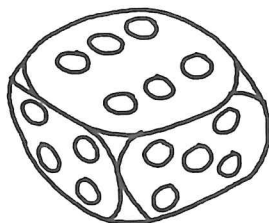

lou

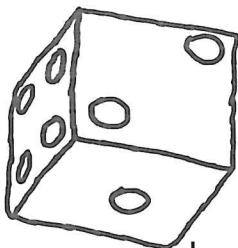

do

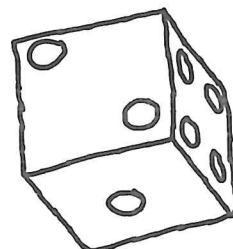

dou

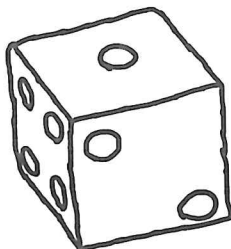

dou

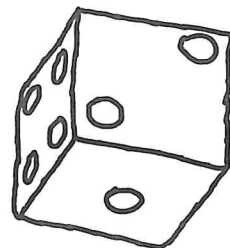

bou

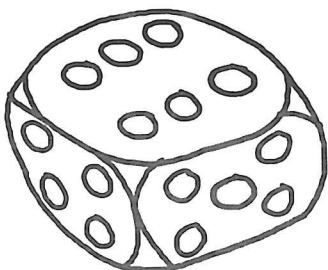

kou

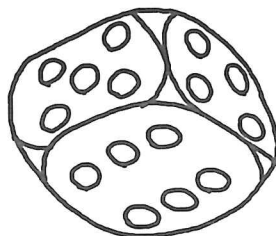

lou

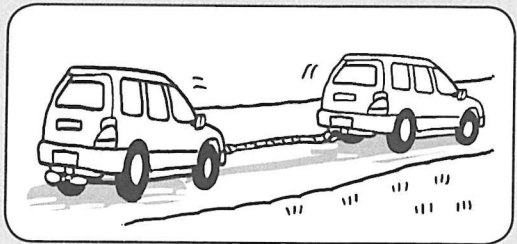
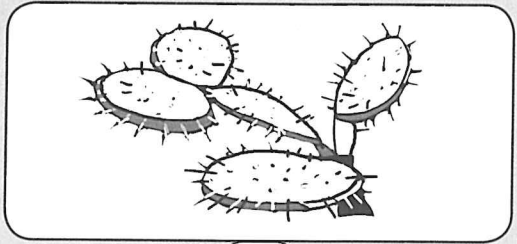
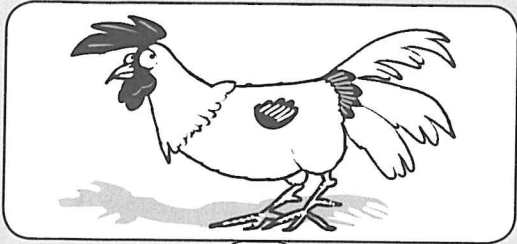

ou

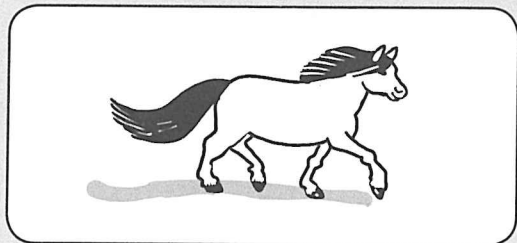
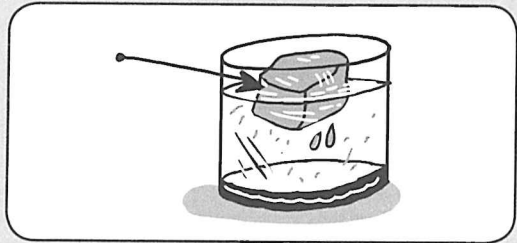
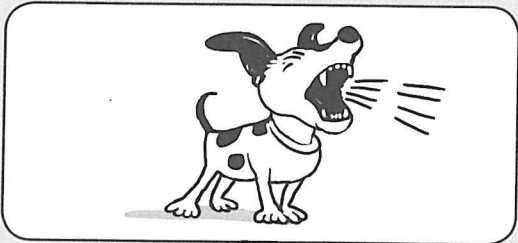

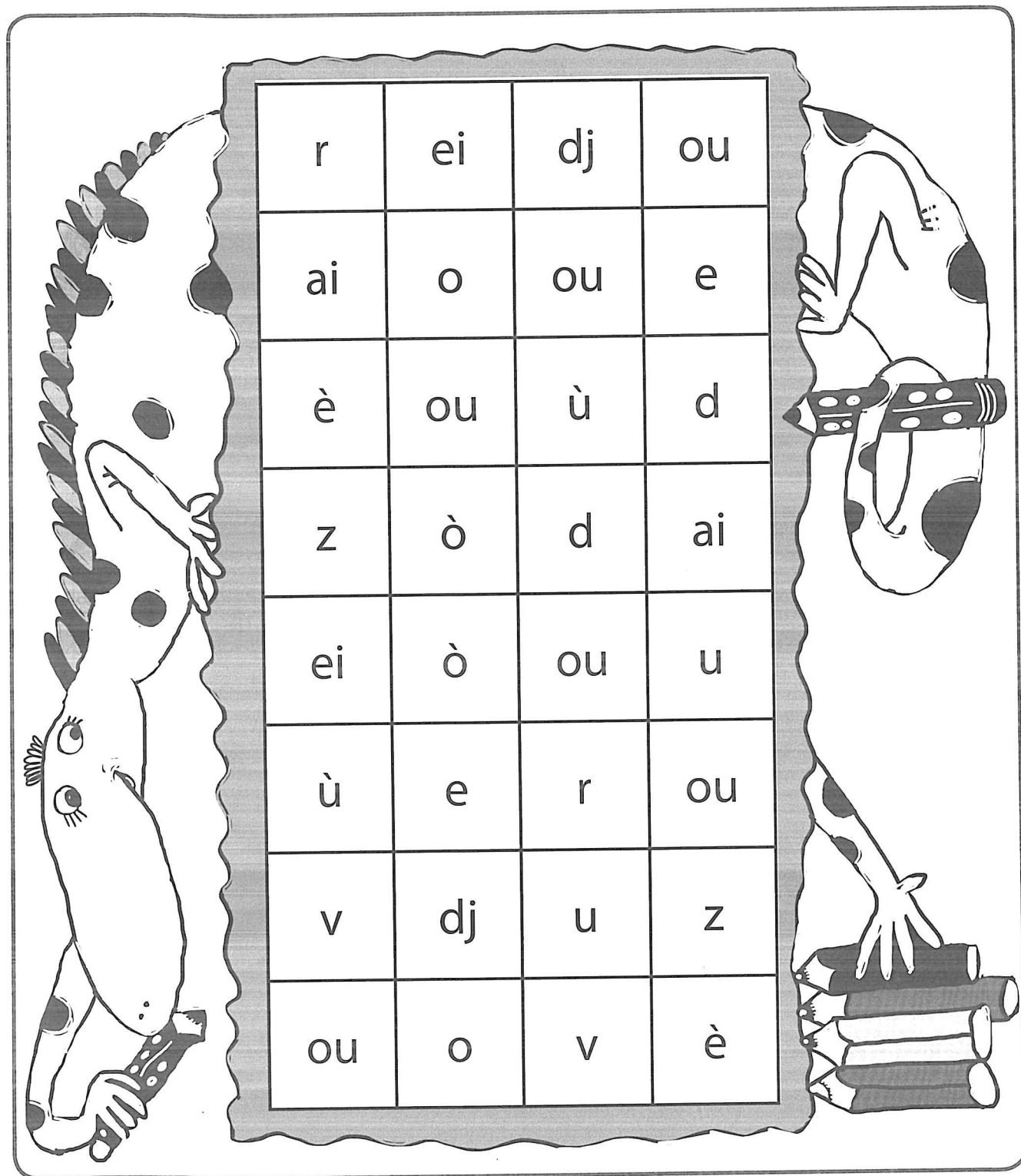



ou  
i  
ai

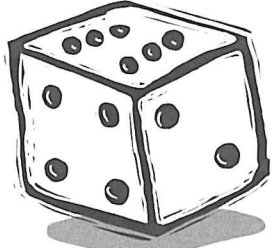

d

ei  
ai  
u



m

n  
w  
m

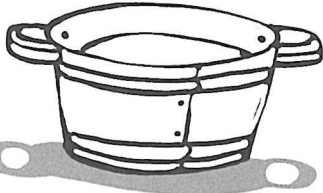

z

i

s  
k  
m



g

a

ei  
ou  
ai



k

e  
ei  
i



r

i  
k  
e

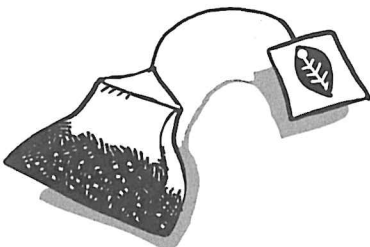

t

ou  
ai  
ei

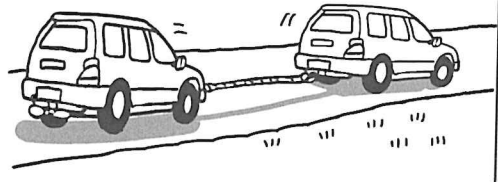

t

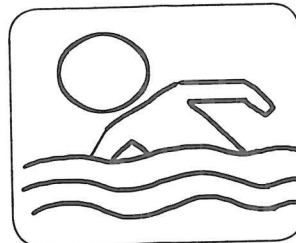
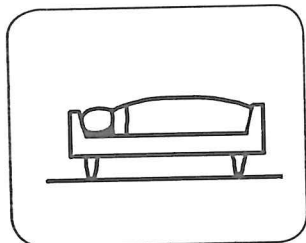
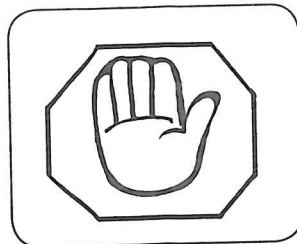
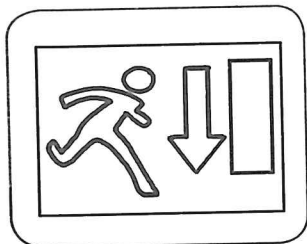
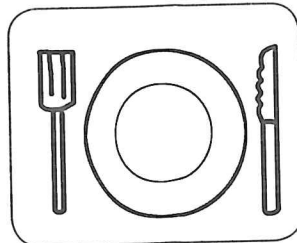
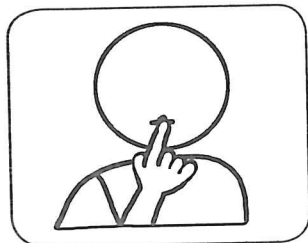
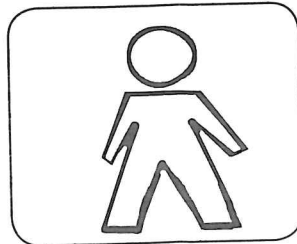
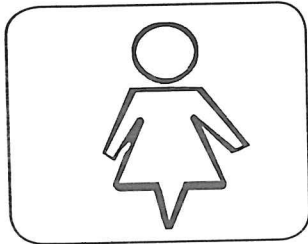
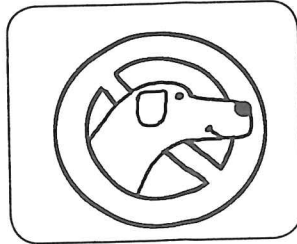
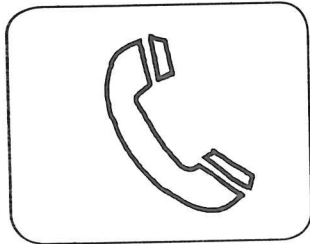



bui

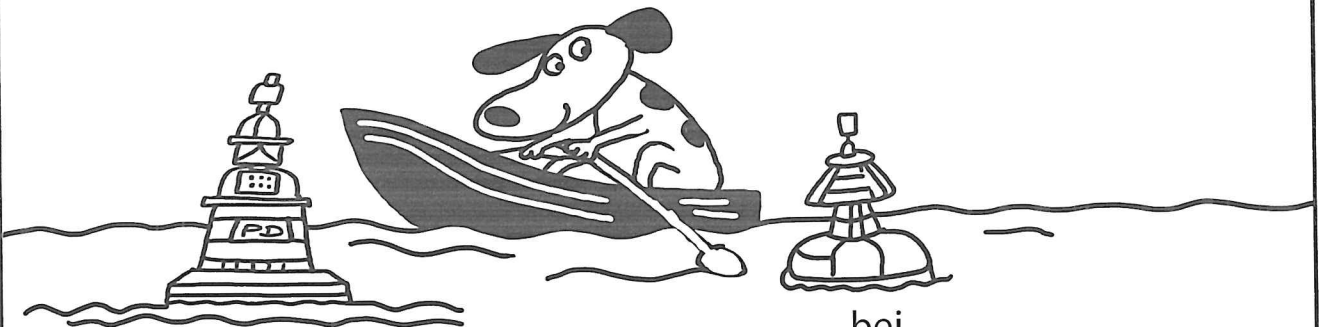

bei

bui

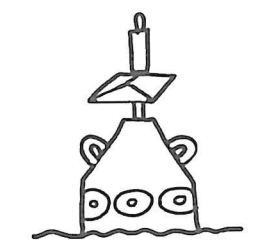
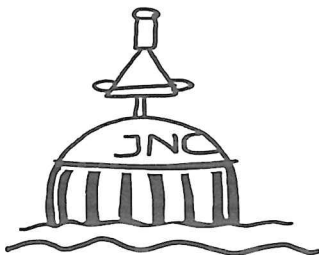

bou



bui

bis

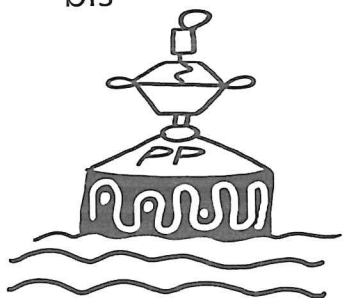

bei

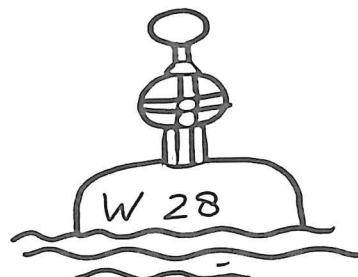
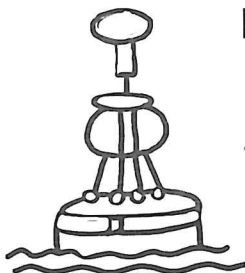

bis

bui

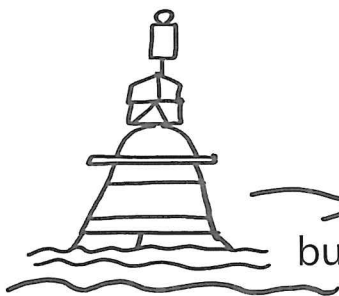

bu

bui



bou

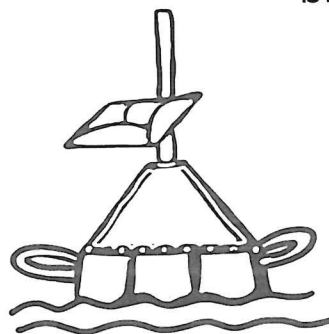

bu



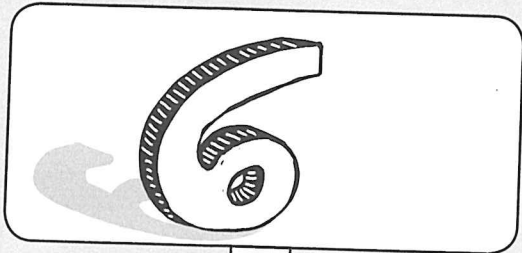
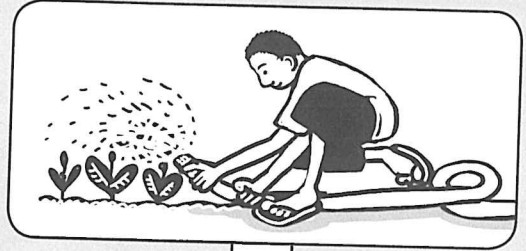
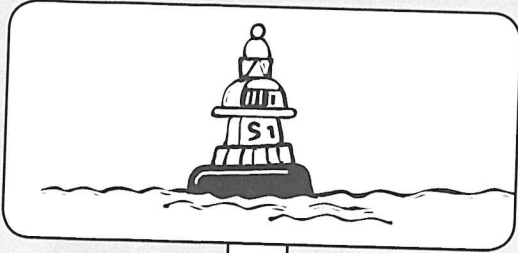

ui

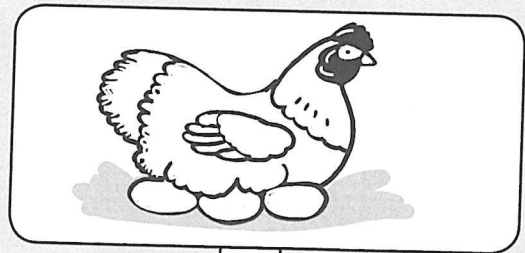
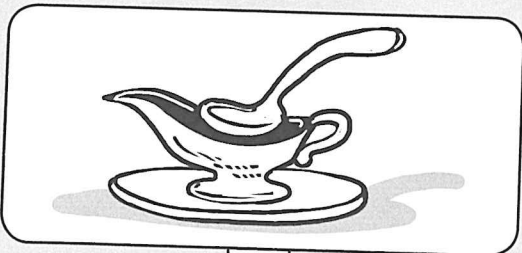
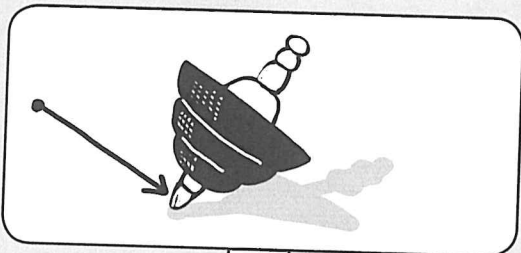

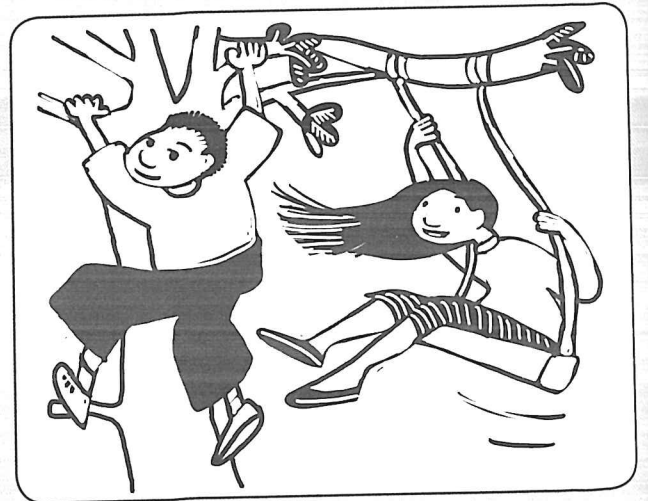
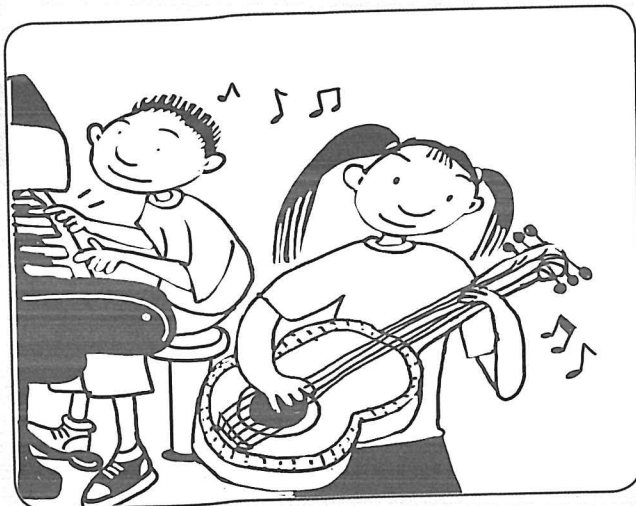

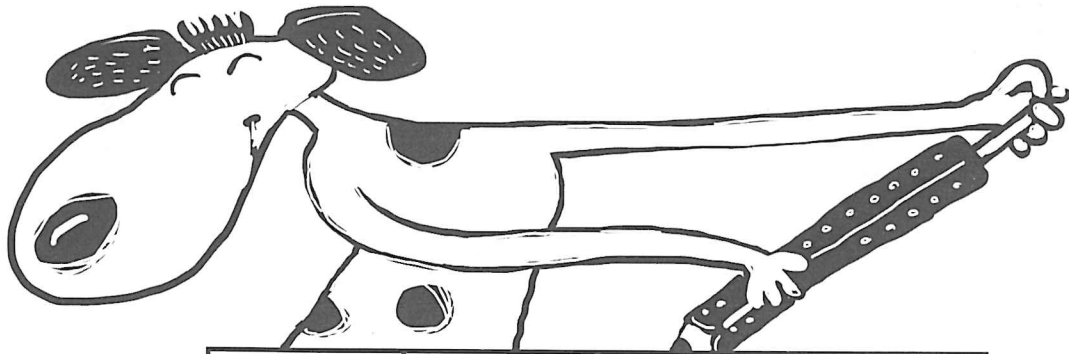

shal	shik	show	mi
shon	ke	shen	bebe
djus	shèf	shòt	shòk
ku	shòp	shou	eis

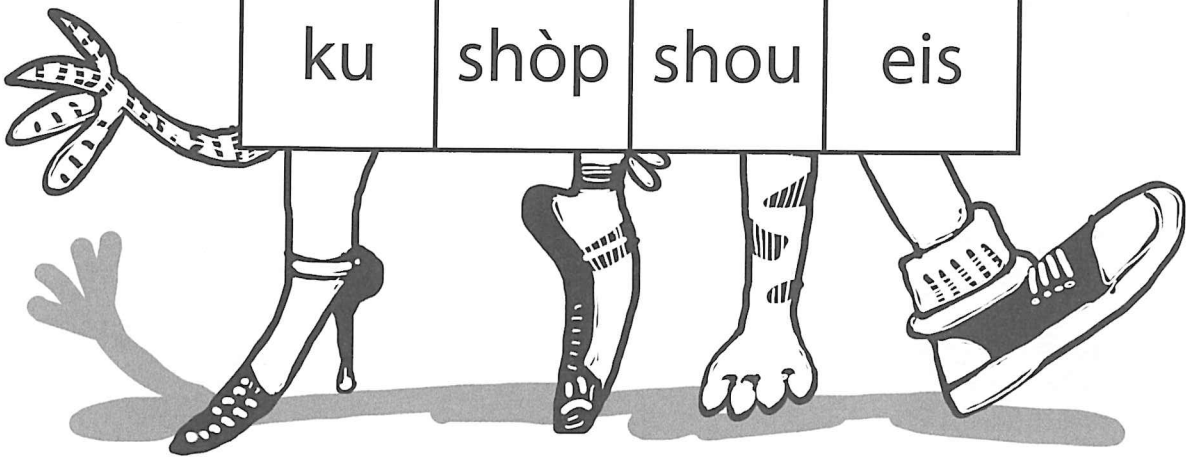

s  
sh  
ai

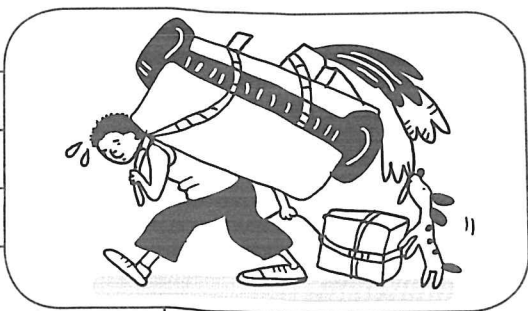

ou

e  
ui  
ei

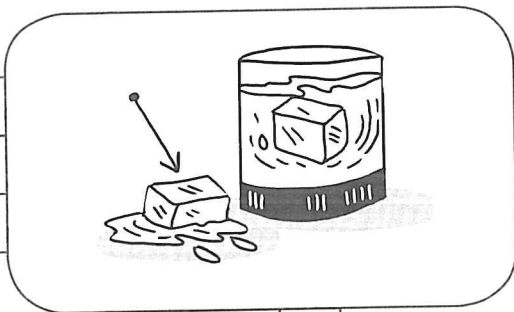

s

l  
h  
b

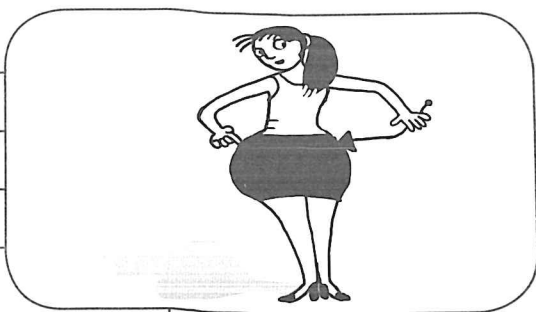

e p

e  
o  
z

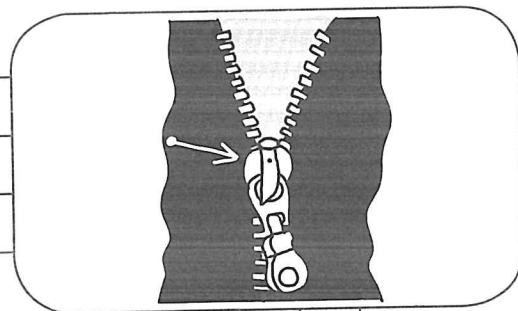

i p

s  
sh  
ai

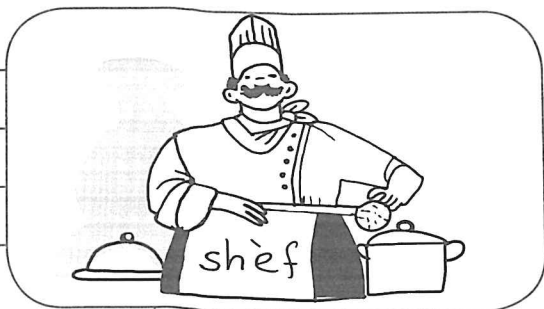

è f

k  
b  
v

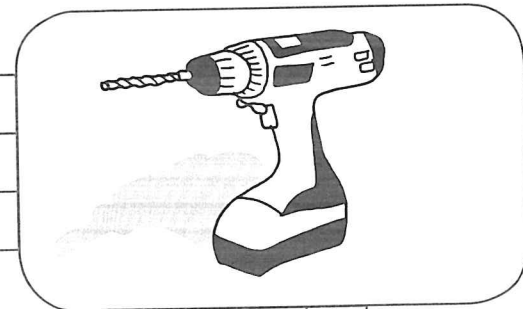

o r

g  
v  
s

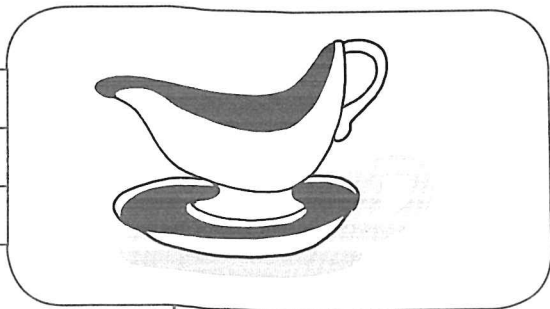

ou s

p  
d  
b

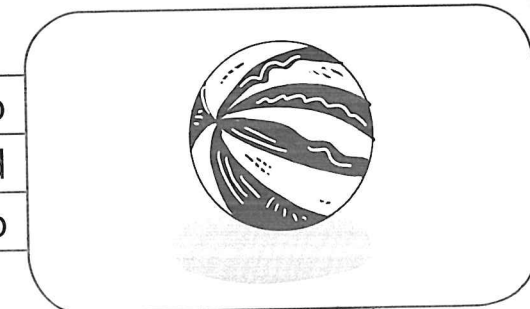

ei k



s
sh
ou
a
l
w

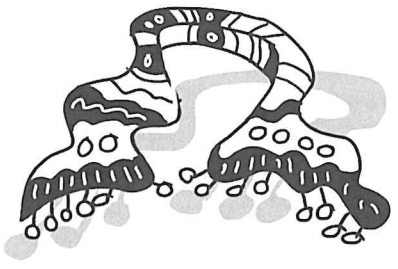

--	--	--

s
d
ò
o
s
p



--	--	--

ei
b
ei
ou
ai
t

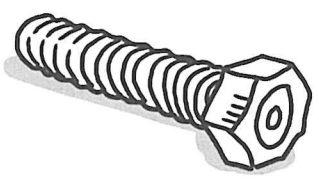

--	--	--

dj
y
i
ou
a
g



--	--	--

t
dj
e
ei
è
m



--	--	--

v
z
e
ei
s
t



--	--	--

w
ei
ai
e
ou
p



--	--

s
sh
ou
o
l
w



--	--	--



- tata tin un shal shik.
- tò'm tin un shal shik.
- fifi tin un shal shik.
- mama tin un shal shik.

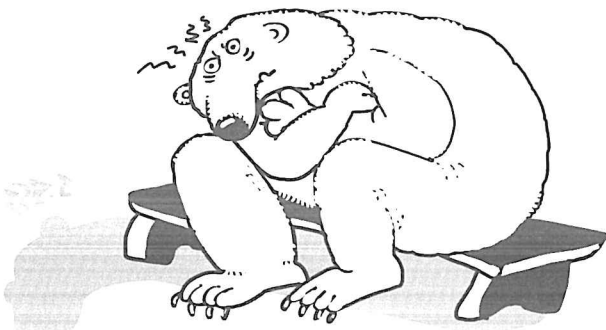

- ui, pai tin mal beis.
- ui, e ber tin mal beis.
- ui, sim tin mal beis.
- ui, mai tin mal beis.



- kiki a tek mi.
- nur a tek mi.
- e gai a pik mi.
- lu a pik mi.

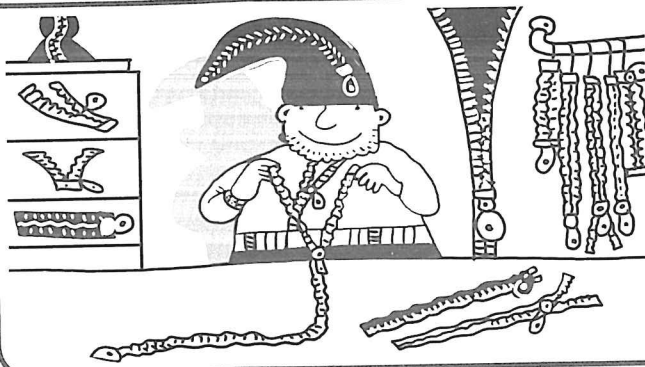

- mai tin mas ku shen vas.
- tata tin mas ku shen bout.
- mama tin mas ku shen mòp.
- pam tin mas ku shen zip.

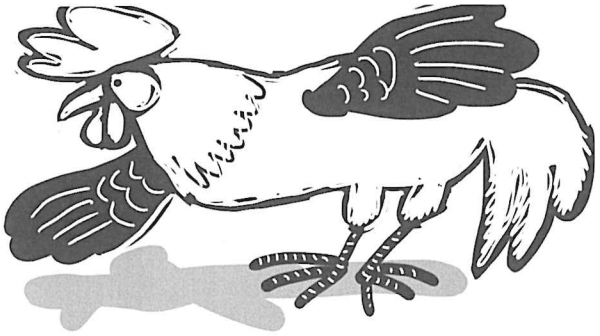

- e ber tin ala.
- sim tin ala.
- e gai tin ala.
- ami tin ala.

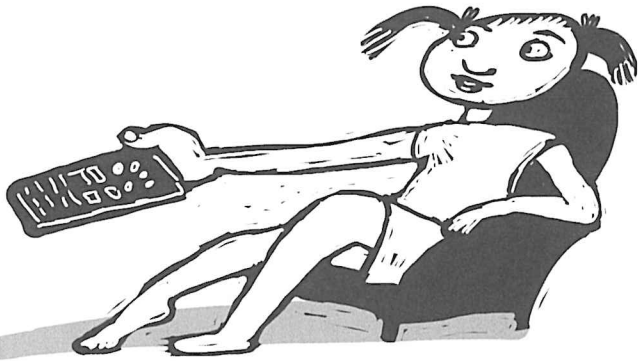

- mama ta hak.
- tata ta bùk.
- nur ta zèp.
- sim ta wou.



- nos ta den rei.
- nos ta bebe te lou.
- nos ta mòp kas.
- nos ta taip bon.

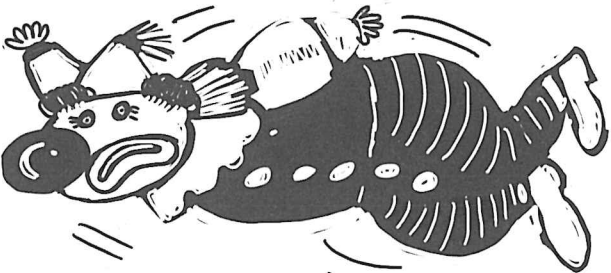

- ui, e pèn a kai abou.
- ui, e yu a kai abou.
- ui, e tas a kai abou.
- ui, bibi a kai abou.

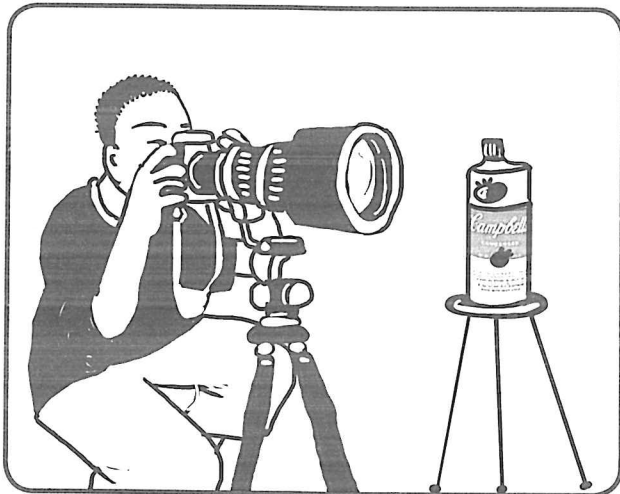
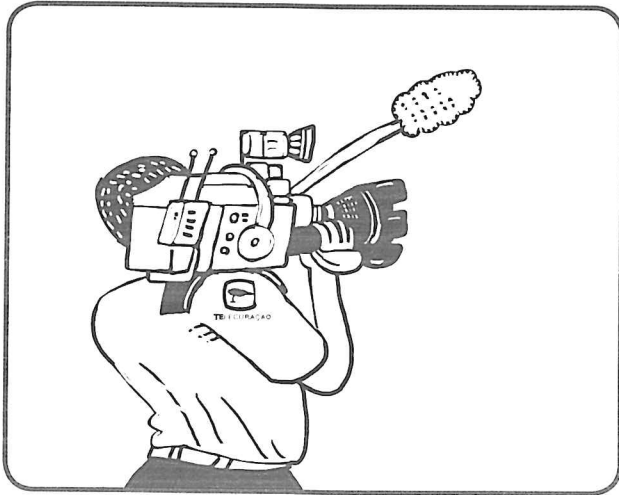



pòst

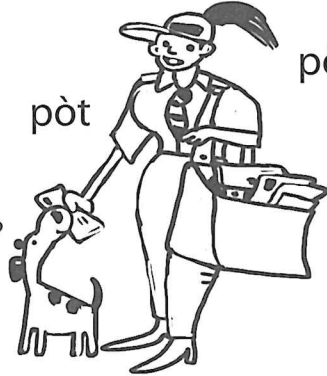

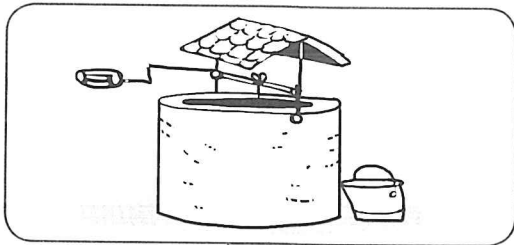
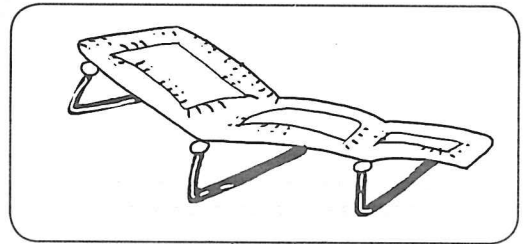
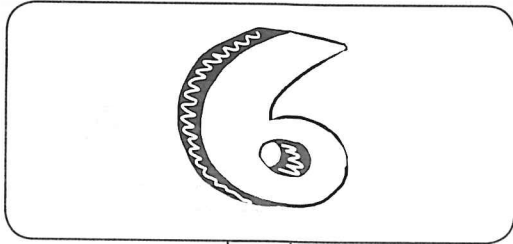
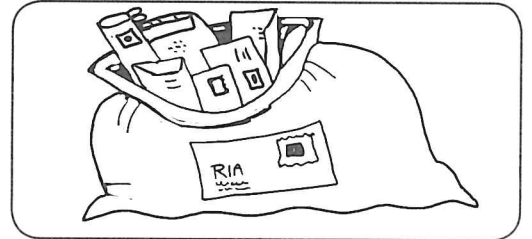
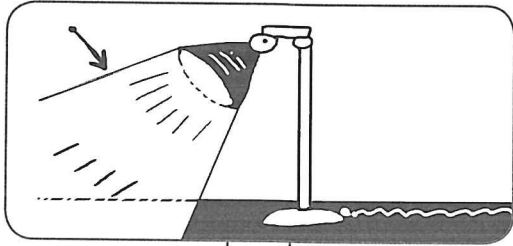

st

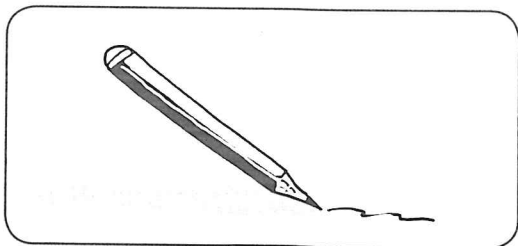
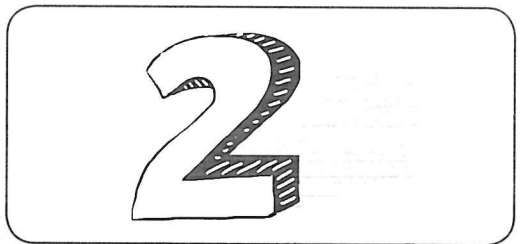
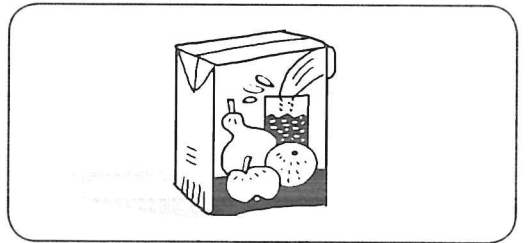

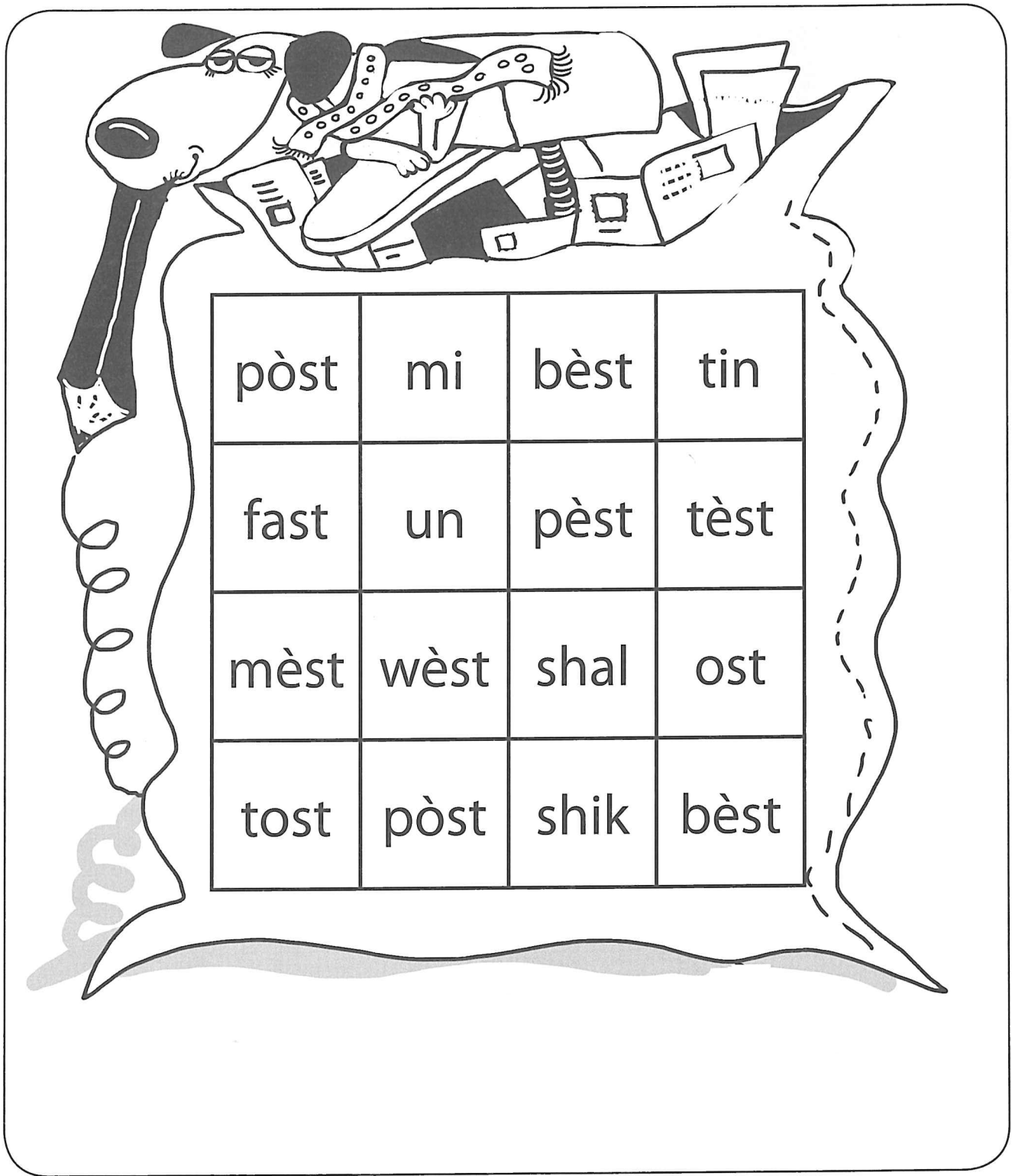

ou  
st  
ai



p o

a  
o  
i

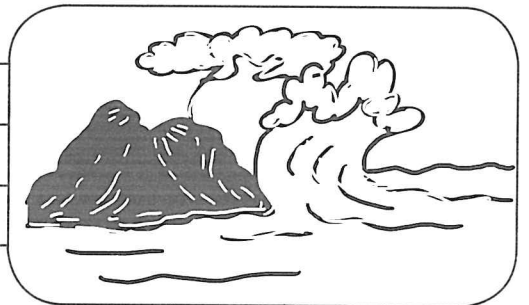

o l

ai  
ou  
ui



sh

ei  
ai  
ui

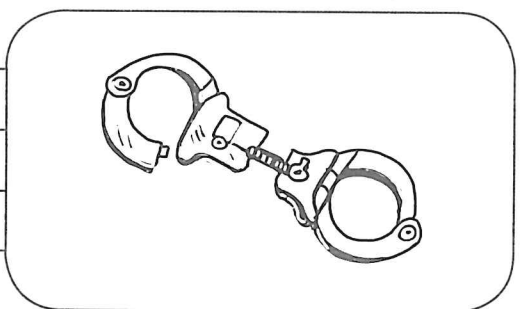

b

st  
ei  
sh

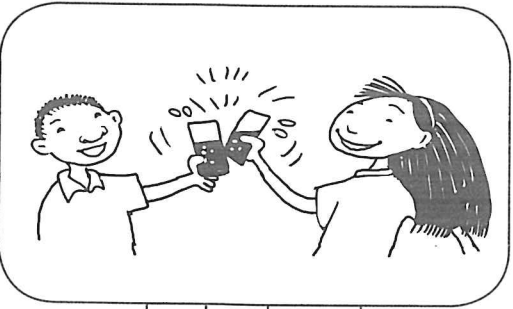

t o

a  
o  
u

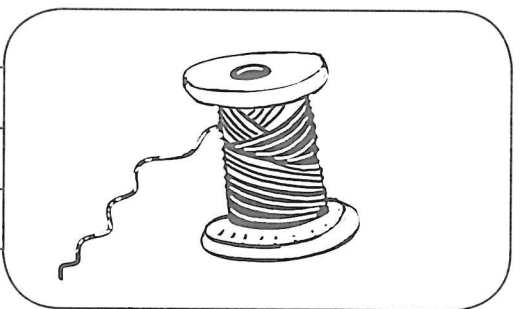

i l

s  
k  
e

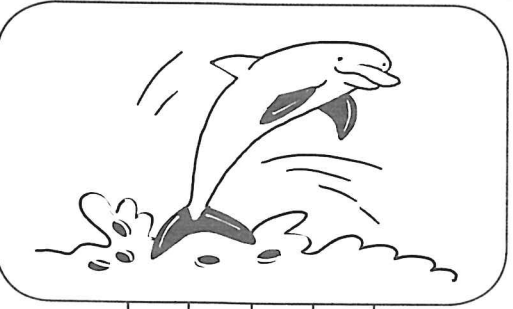

p e p

a  
o  
ei

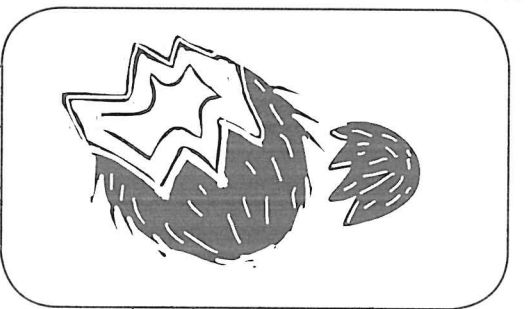

k o k





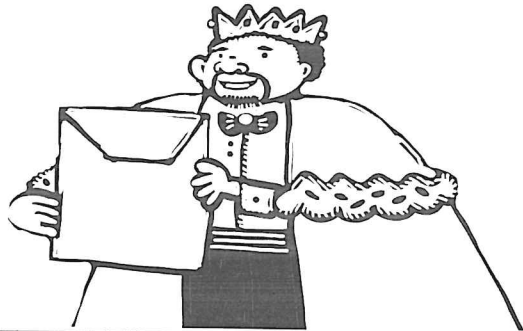

- tin pòst pa pai.
- tin pòst pa pam.
- tin pòst pa e rei.
- tin pòst pa tè.

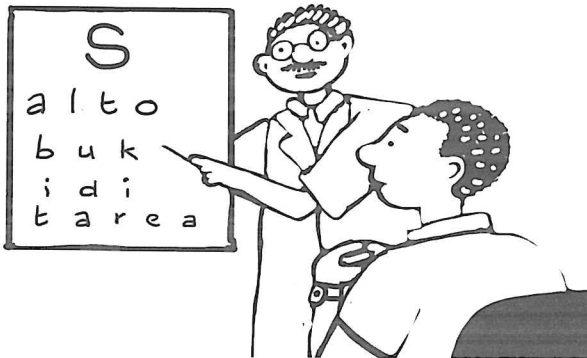

- mama ta tèst su djip.
- tata ta tèst su djip.
- mama ke tèst wowo.
- tata ke tèst wowo.



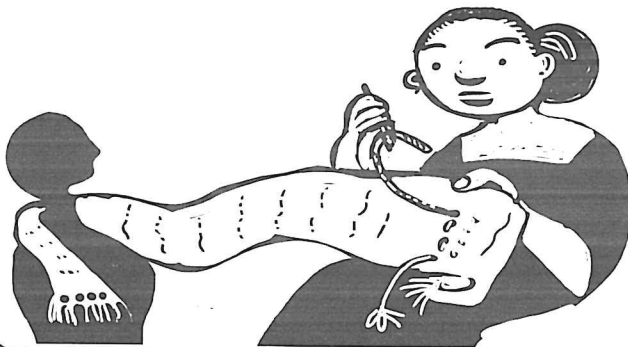

- tin un yeye na e het.
- tin un yeye den e sous.
- tin un yeye den e djèm.
- tin un yeye na e lus.

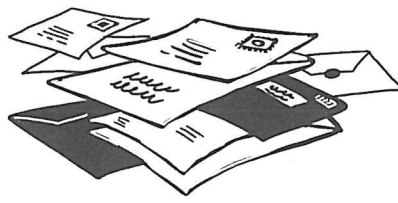

- fifi ta bebe djus.
- mama ta zòm e shal.
- tò m ta leim e fèn.
- nur a kap su lep.

p			
o			
u			
ò			
l			
st			

s			
a			
ei			
l			
k			
a			

dj			
d			
e			
è			
s			
m			

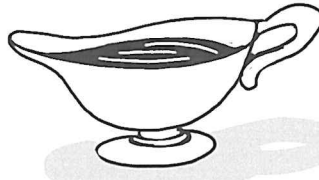
t			
s			
o			
ou			
ei			
s			
p			

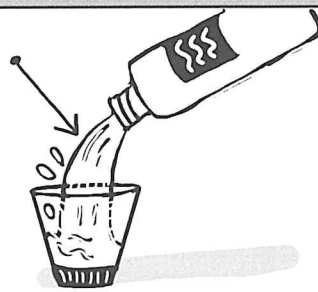
ai			
a			
ei			
w			
a			
o			

t			
ou			
ò			
o			
st			
p			

d			
ui			
ai			
ou			
ei			
sh			

o			
b			
u			
e			
ui			
t			

tin pòst pa soul. ●

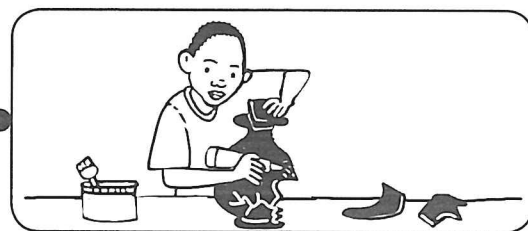

djòn ta leim e vas. ●

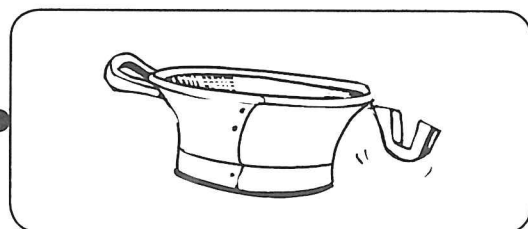

e bui ta den awa. ●



e man di e zim ta lòs. ●



ana tin un shal shik. ●

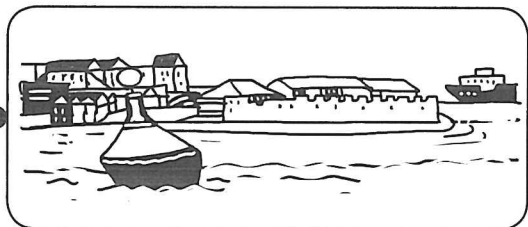

mama ta bùk pa e stòf e stul. ●

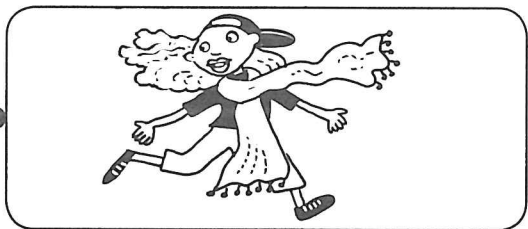

blas

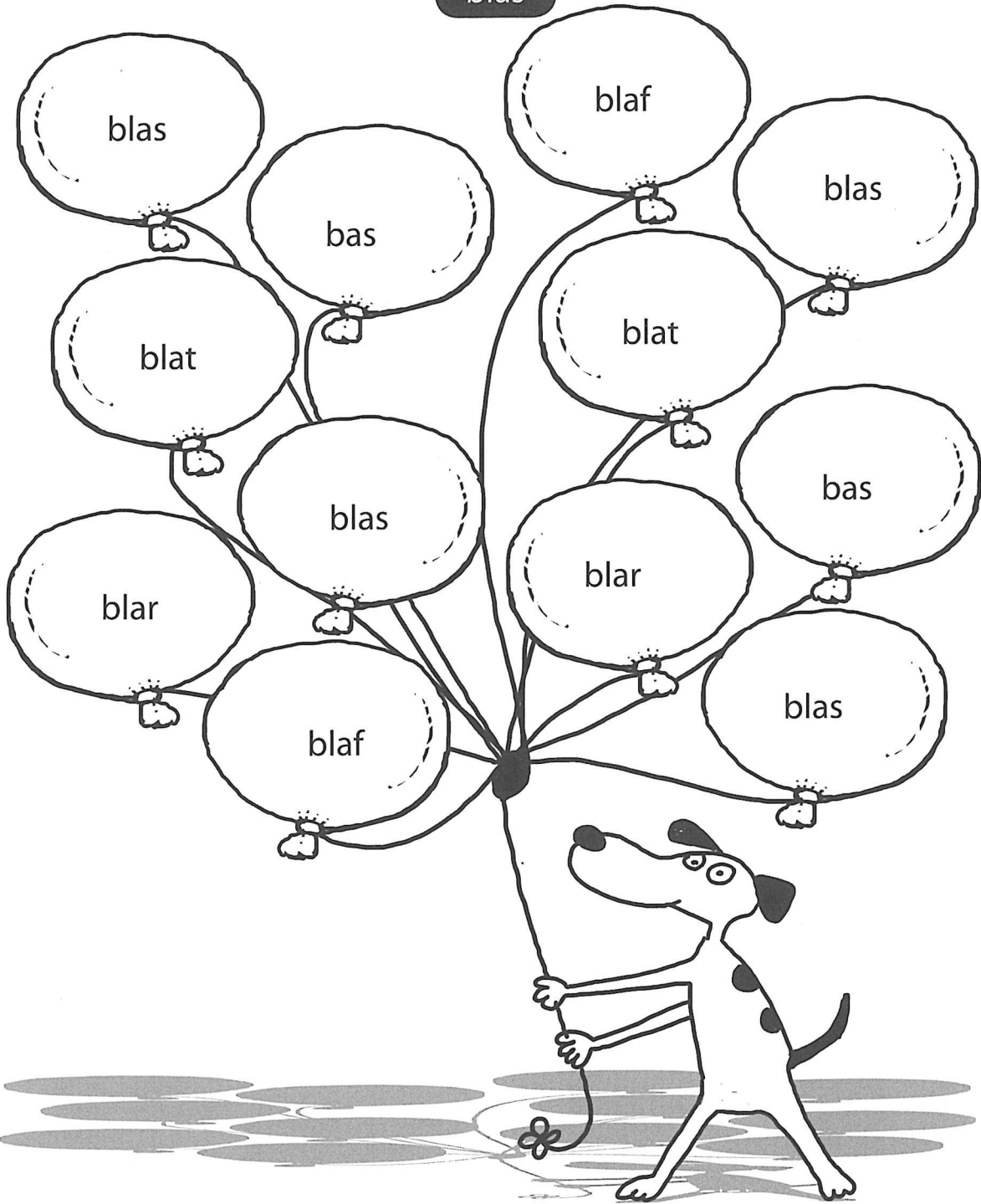



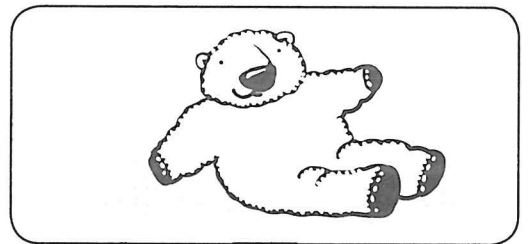
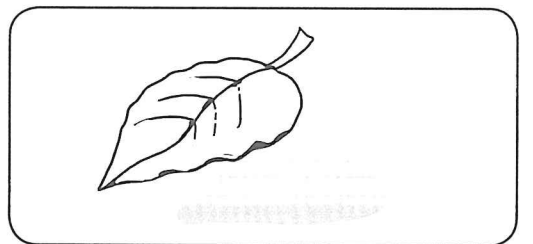
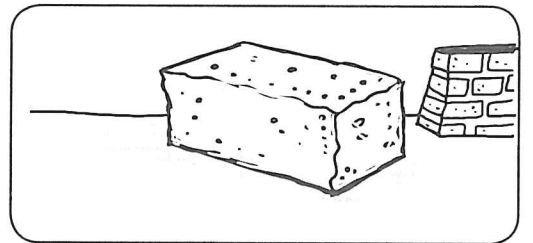
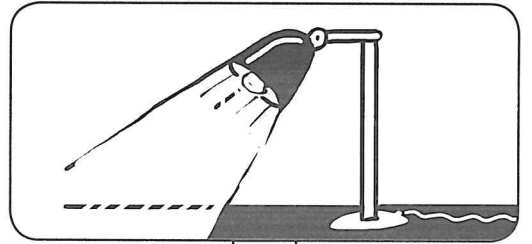
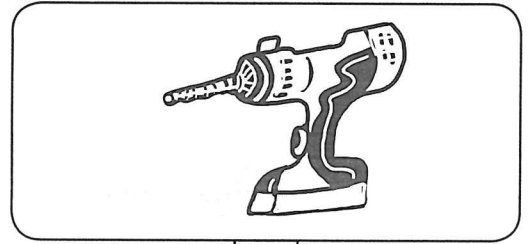
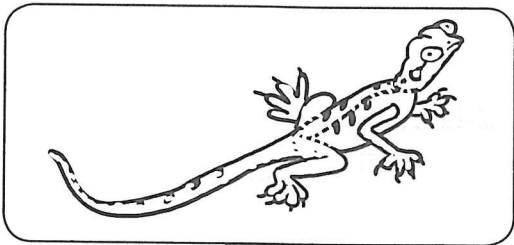
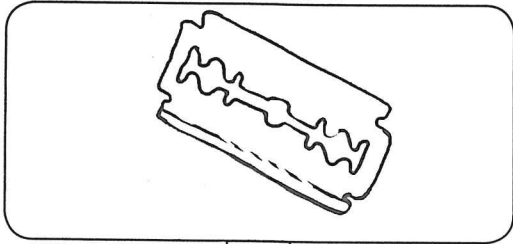
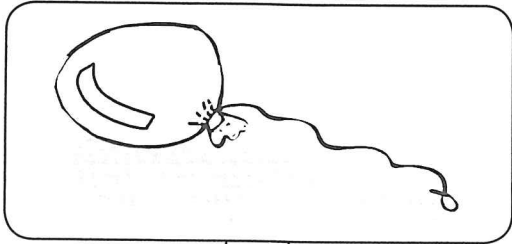

bl

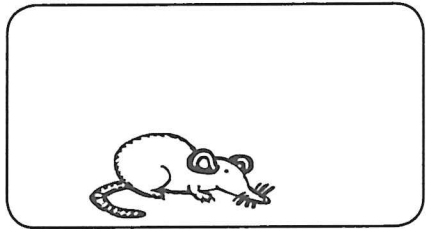
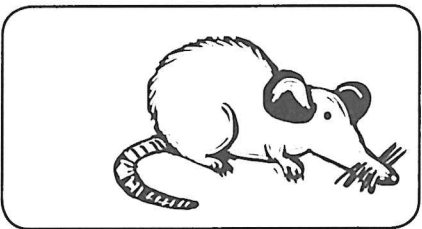
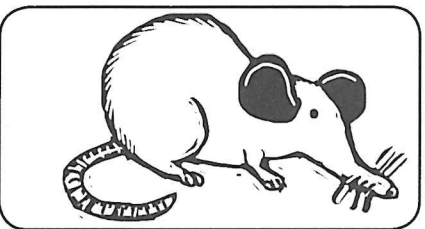
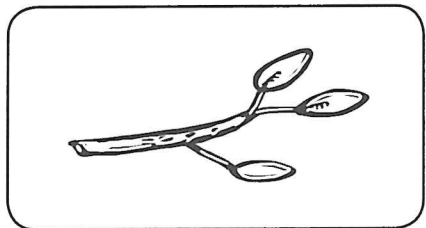
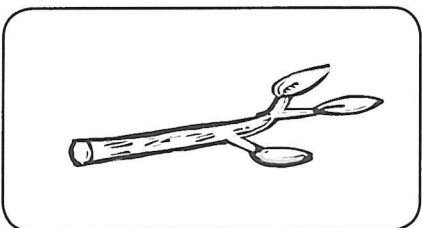
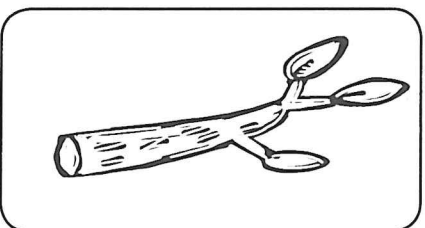
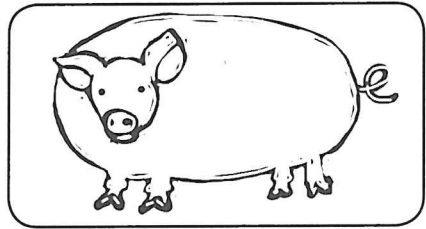
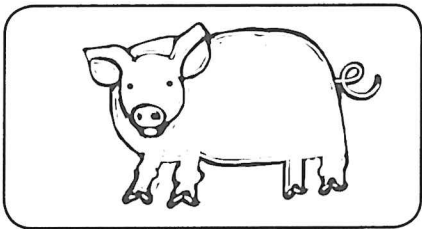
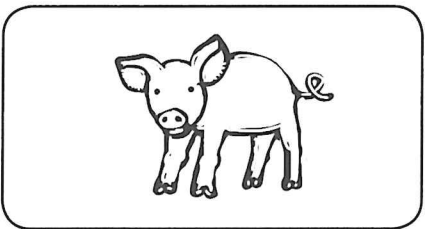
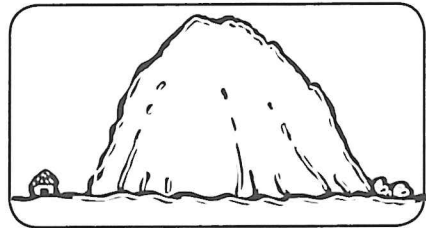
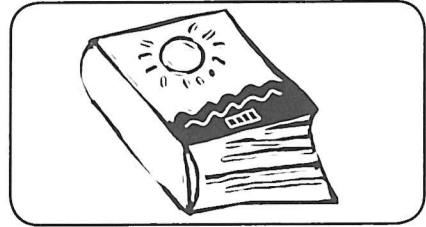
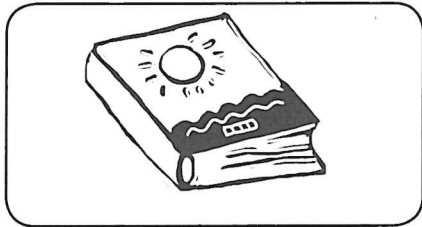
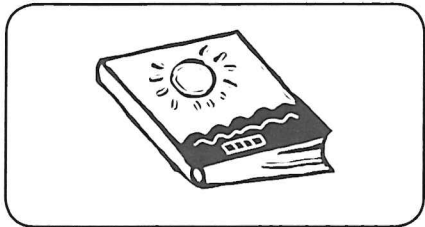
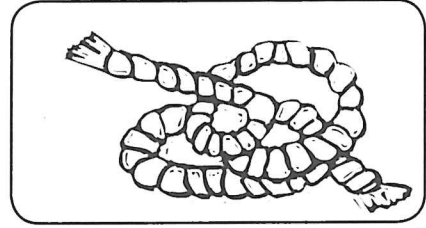
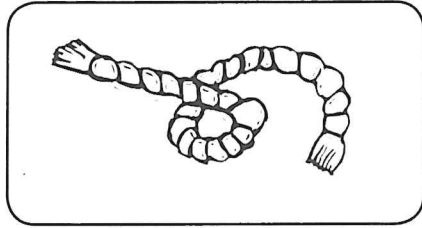
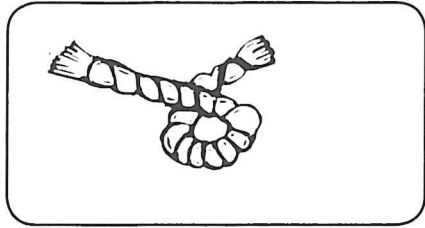



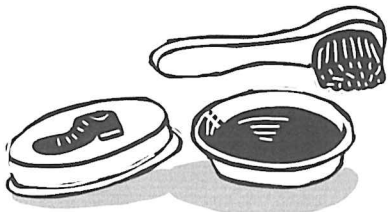

blas blas blas blas blas blas

blas blas blas blas blas blas

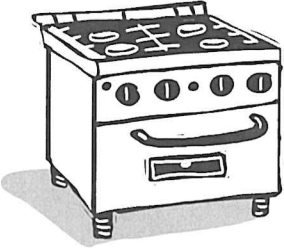

s			
bl			
è			
ai			
k			
s			
	<input type="text"/>	<input type="text"/>	<input type="text"/>

st			
dj			
sh			
e			
o			
f			
	<input type="text"/>	<input type="text"/>	<input type="text"/>

s			
d			
ò			
o			
k			
s			
	<input type="text"/>	<input type="text"/>	<input type="text"/>

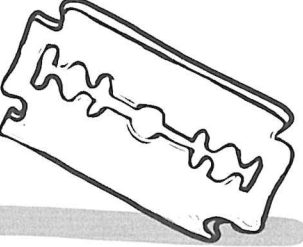
ai			
sh			
st			
u			
n			
l			
	<input type="text"/>	<input type="text"/>	<input type="text"/>

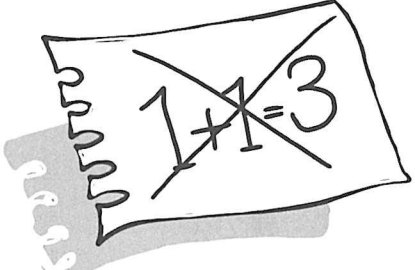
t			
bl			
ou			
ei			
e			
t			
	<input type="text"/>	<input type="text"/>	<input type="text"/>

f			
ai			
ou			
ei			
k			
t			
	<input type="text"/>	<input type="text"/>	<input type="text"/>

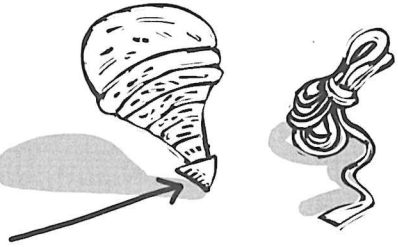
p		
ai		
ei		
ui		
s		
r		
	<input type="text"/>	<input type="text"/>

p		
d		
ei		
ui		
ou		
ai		
	<input type="text"/>	<input type="text"/>

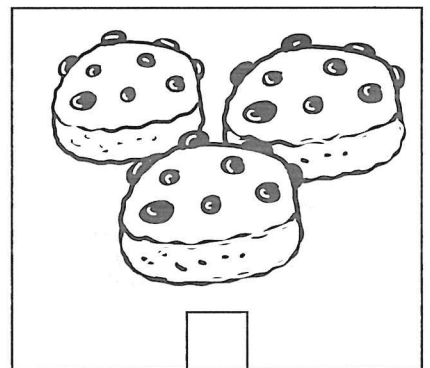
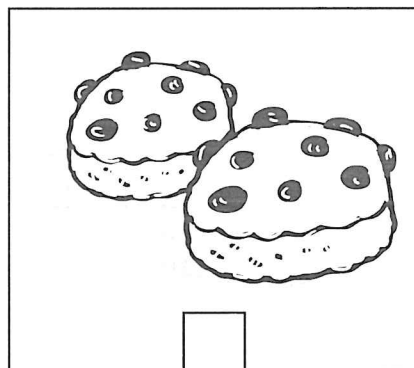
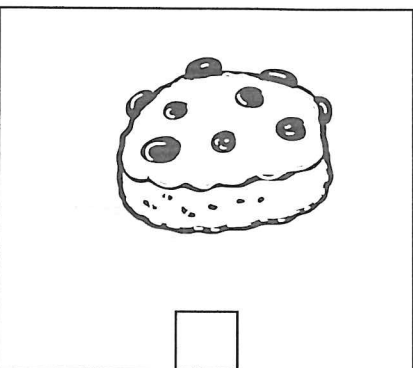
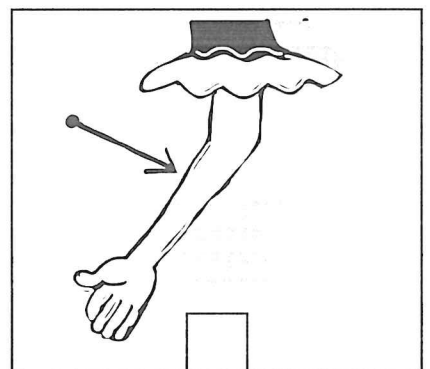
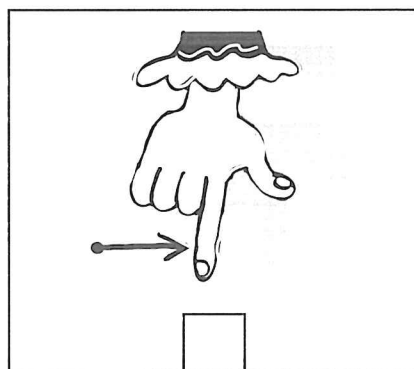
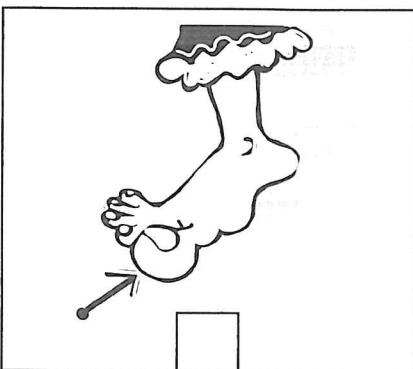
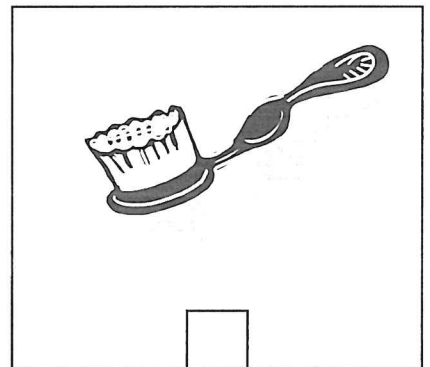
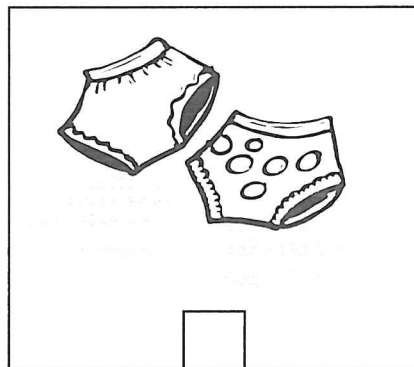
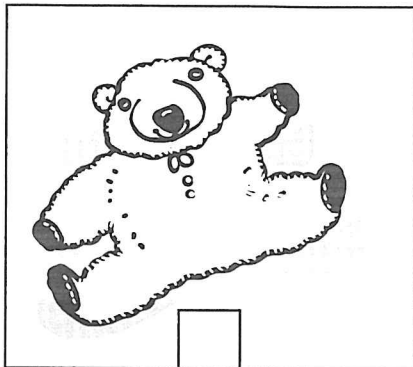



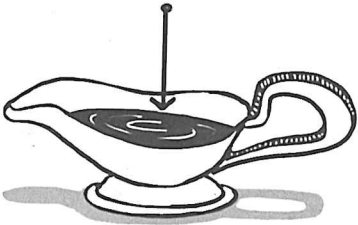

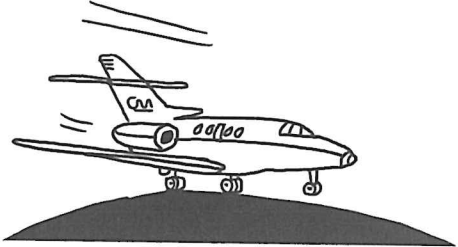
s	
v	
ou	
ai	
l	
s	
	<input type="text"/>

o	
dj	
è	
e	
o	
t	
	<input type="text"/>

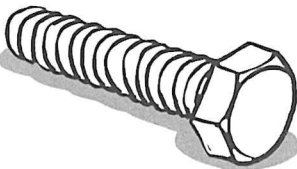
s	
e	
ei	
è	
s	
p	
	<input type="text"/>

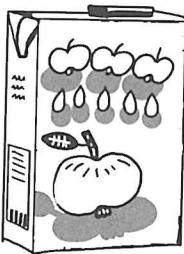
ai	
b	
ei	
ou	
n	
t	
	<input type="text"/>

dj	
d	
ù	
u	
s	
r	
	<input type="text"/>

t	
l	
ou	
ei	
m	
p	
	<input type="text"/>

t	
ou	
ai	
e	
s	
p	
	<input type="text"/>

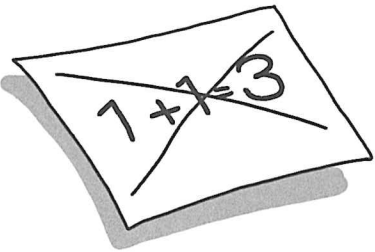
f	
ai	
ou	
ei	
k	
t	
	<input type="text"/>



- tès ke te.
- tès ke pan.
- tès ke ham.
- tès ke sous.

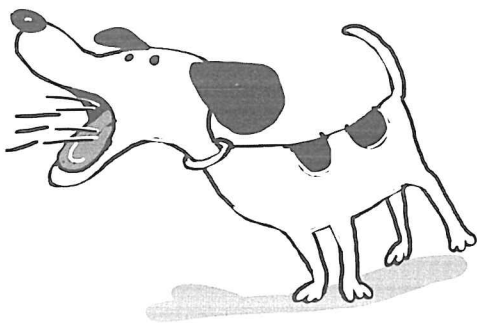

- sim ta bai kas.
- sim ta wou.
- sim ta kai.
- sim ta bebe a-wa.



- nan a tou e djèt.
- nan a tou e vèn.
- nan a tou e bès.
- nan a tou e djip.

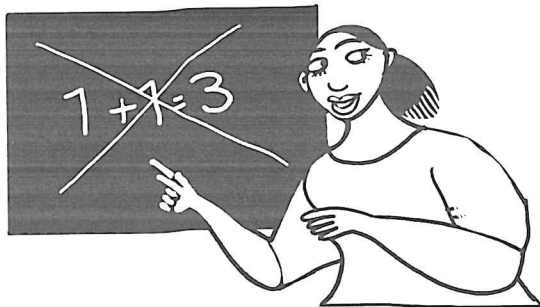

- yùf di: 'e sòm ta bon.'
- tata di: 'e sòm ta bon.'
- yùf di: 'e sòm ta fout.'
- tata di: 'e sòm ta fout.'

ou  
ui  
ai

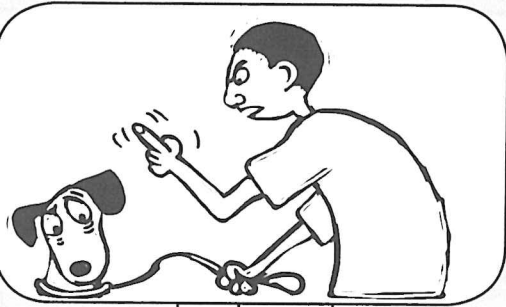

f

ou  
ui  
ai

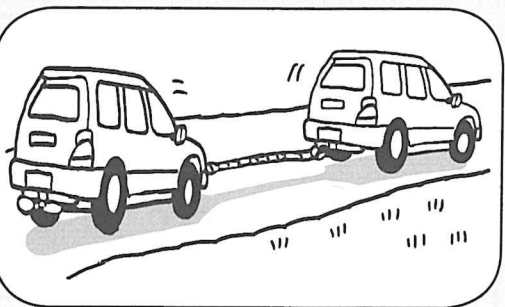

t

e  
ei  
è

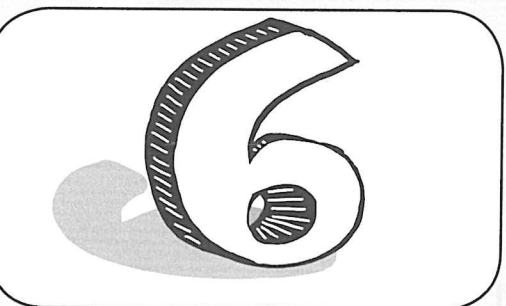

s

ai  
o  
ou



s

ou  
ei  
ai

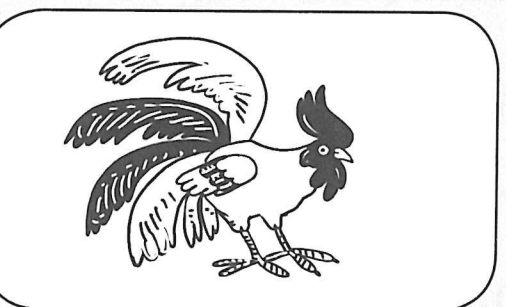

g

ui  
ei  
i

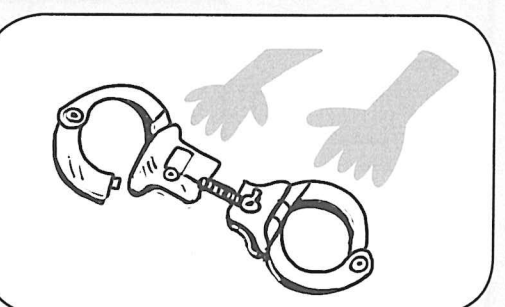

b

ù  
u  
a

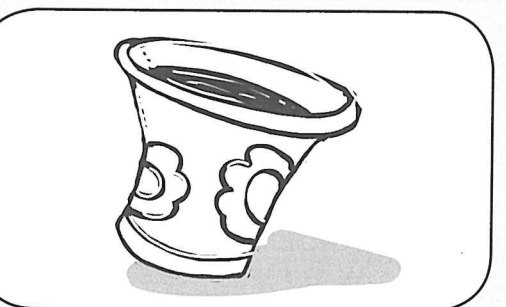

k

o  
ò  
ou

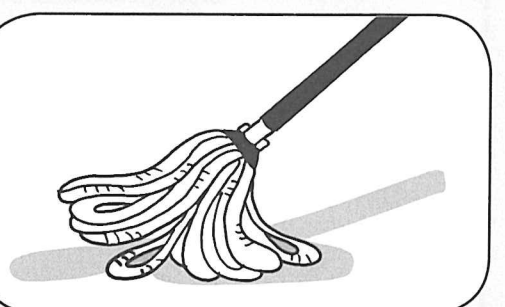

m

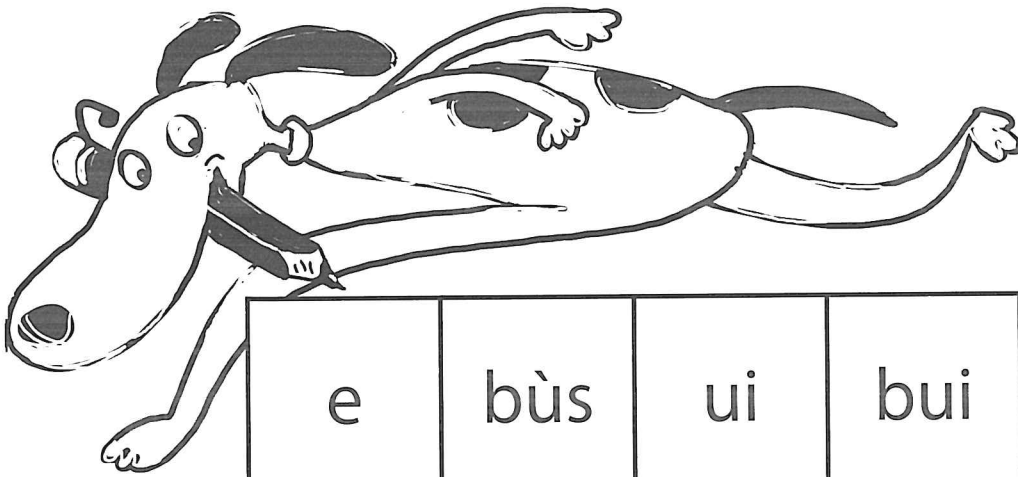

e	bùs	ui	bui
hel	dui	fui	ta
pui	ui	bui	dui
fui	lat	pui	ui

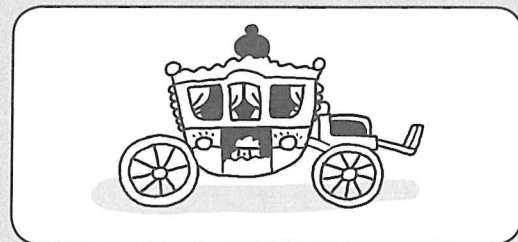
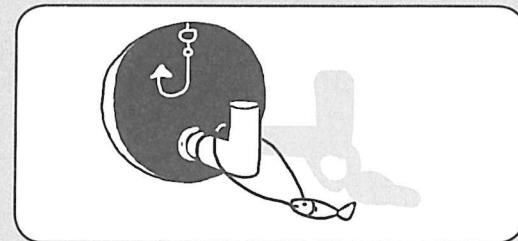
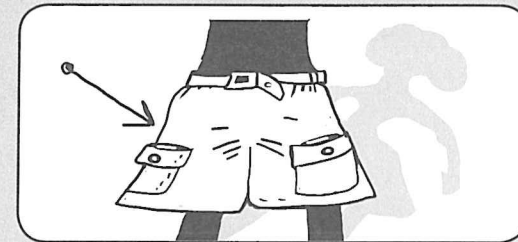
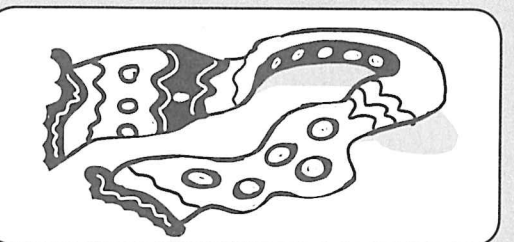
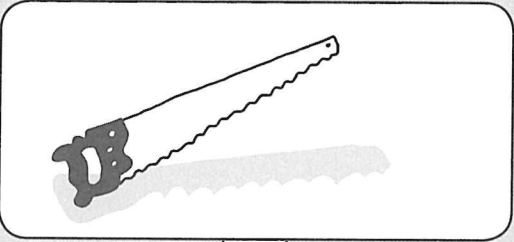
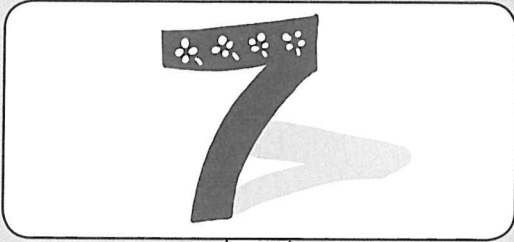

sh





shal

shut

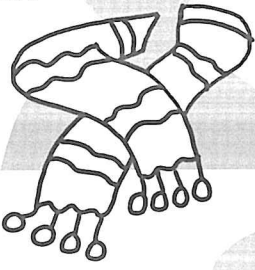

shik

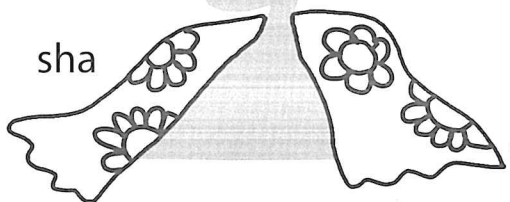

sha

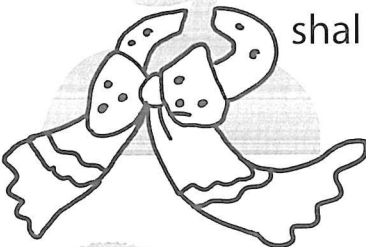

shal



shal

shut

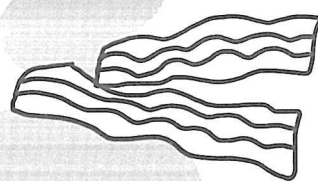

shal

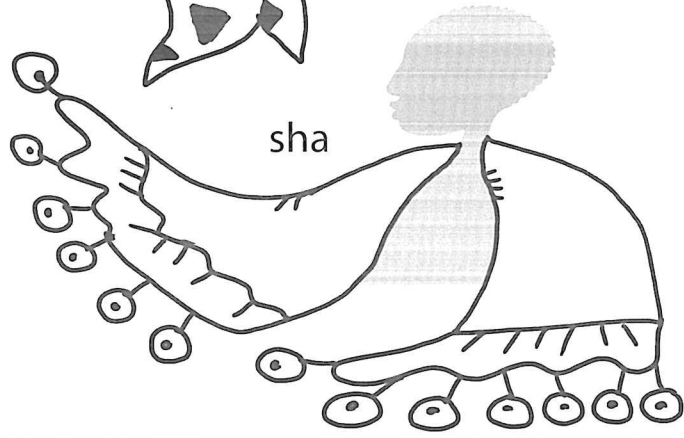

sha

shik

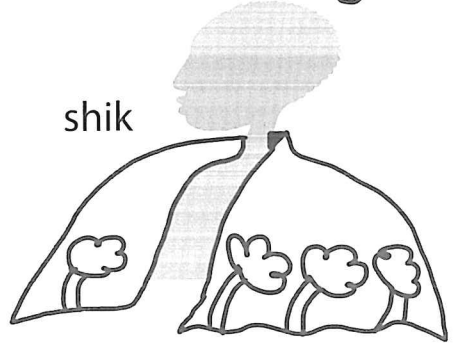

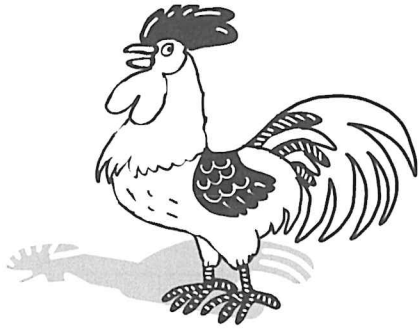

- e ber tin un kam.
- e rei tin un kam.
- e gai tin un kam.
- e yu tin un kam.



- tò m ta mò p.
- tò m ta yag.
- tò m ta bù k.
- tò m ta rè p.

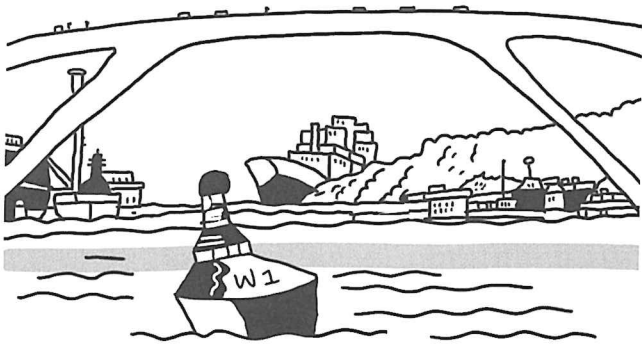

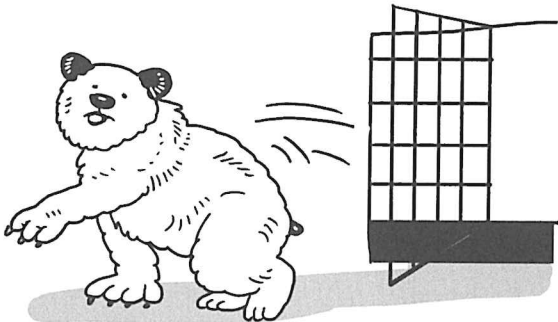

- e bui ta den kas.
- e bui ta den gol.
- e bui ta den haf.
- e bui ta den wig.

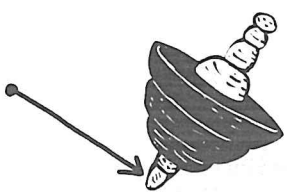

- ui, e ber a kai.
- ui, e ber ta hik.
- ui, e ber ta lur.
- ui, e ber a lò s.

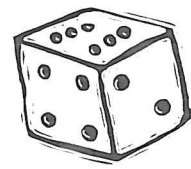
p			
ai			
ou			
ai			
ui			
i			

o			
dj			
d			
o			
ou			
t			

r			
e			
ei			
è			
p			
s			

a			
p			
ei			
ou			
ai			
t			

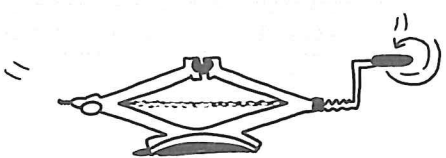
dj			
d			
è			
e			
s			
k			

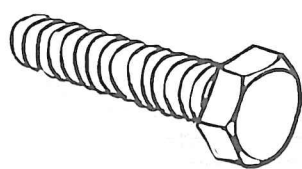
b			
ei			
ai			
ou			
s			
t			

t			
b			
ou			
ei			
ui			
p			

f			
r			
ou			
o			
ò			
l			

bl  
st  
ai

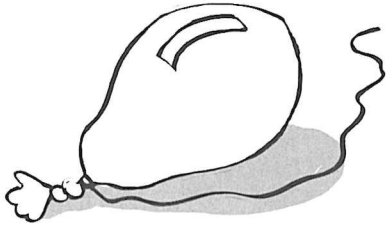

   a   s

ui  
sh  
st



   è   p

k  
s  
m



   ou   s

sh  
ui  
bl



   a   l

ei  
ou  
bl

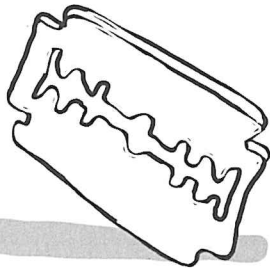

   e   t

sh  
st  
s

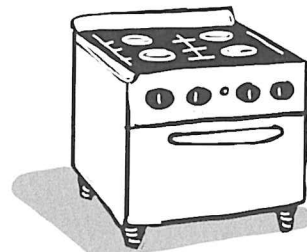

   o   f

a  
i  
e

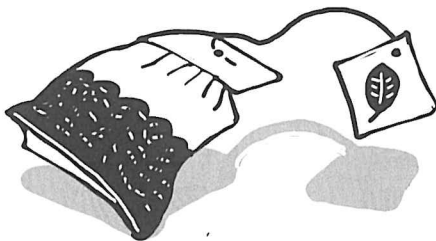

t   

ou  
ui  
ei

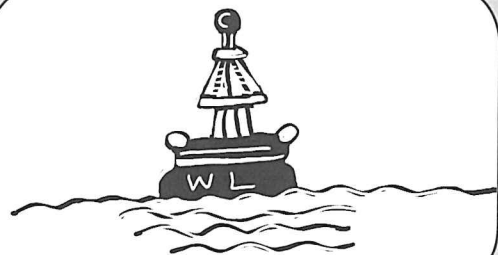

b



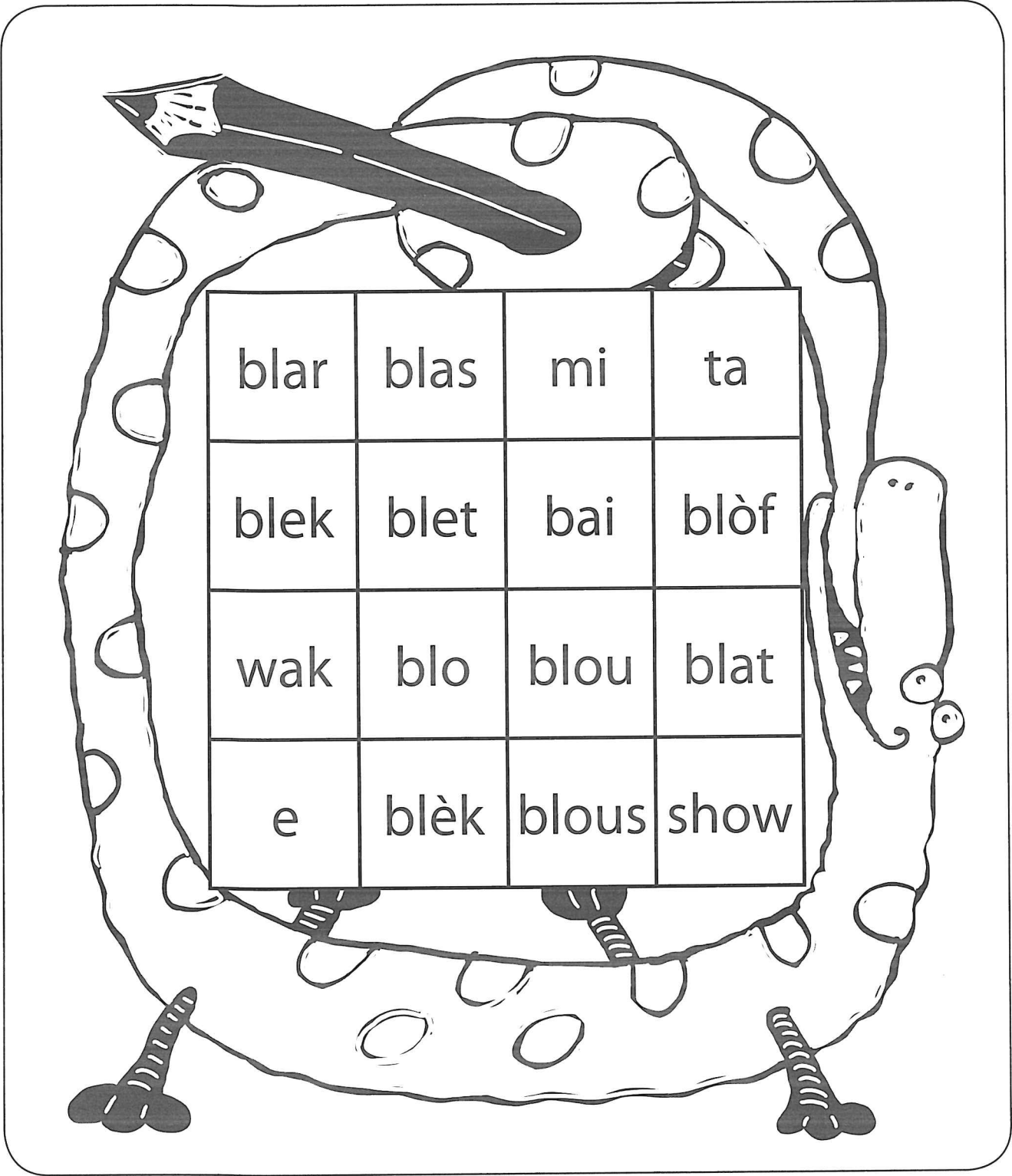





Método pa siña lesa na Papiamentu

## buki di tarea 5

Tim di outor

Ronnie Severing • Ria Severing-Halman  
Mavis Ersilia • Ilona Berggraaf-Karsters  
Karen Specht • Marelva Mathilda • Sharine Juliana

Ilustrashon

Anjo Mutsaars

Realisashon

Paul Dijkstra, Wietske Dijkstra

Salto, Buki di tarea 5  
ISBN: 978-99904-2-250-4

© 2009 Fundashon pa Planifikashon di Idioma  
Derecho reservá. No ta pèrmití pa reproducí nada di e edishon akí di ningun  
forma, ni pa ningun medio, sin outorisashon previo i skibi di editor.



Fundashon pa  
Planifikashon di  
Idioma

gl  
sh  
ai

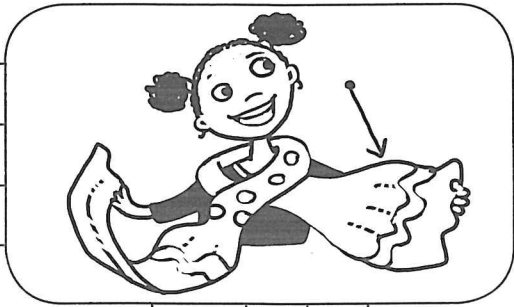

   a   l

k  
z  
st

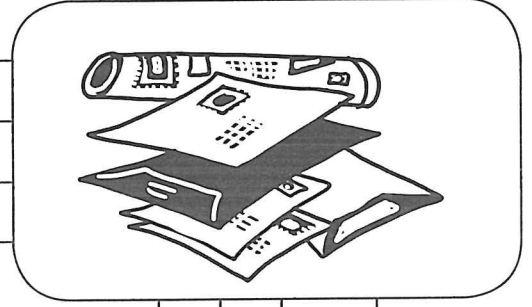

p   ò   

sl  
st  
bl

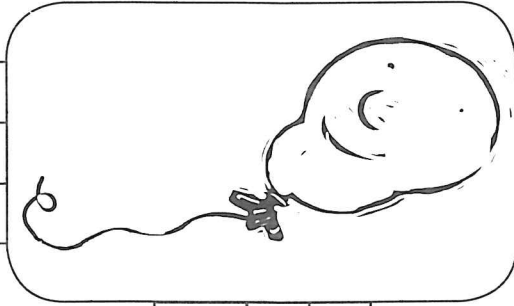

   a   s

ai  
ou  
ui

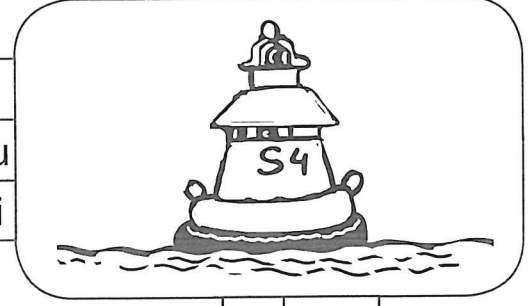

b   

ei  
dj  
ou

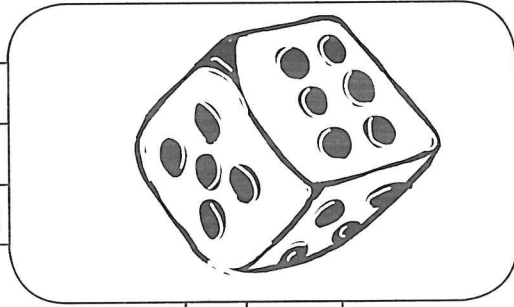

d

gl  
kl  
ai



a s

s  
st  
sh



a l

sl  
sh  
st



è p

a  
l  
ò



d a

ei  
dj  
ou

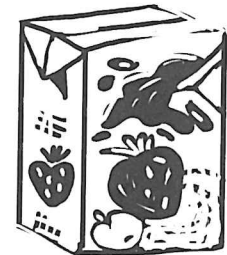

u s

bl  
vl  
sl

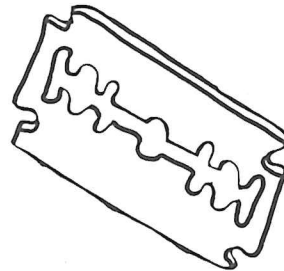

e t

u  
ù  
ui



b

ai  
ou  
ei

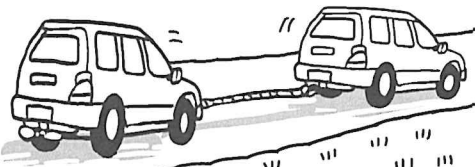

t

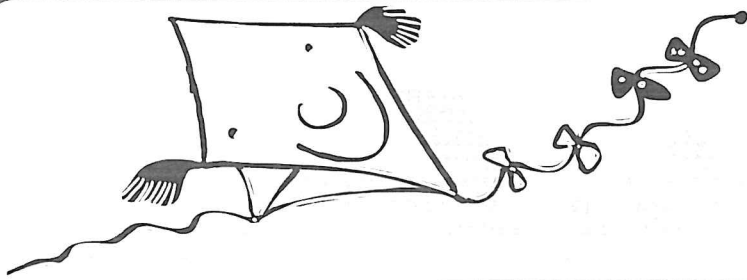

- flor
- fli
- flus
- flur

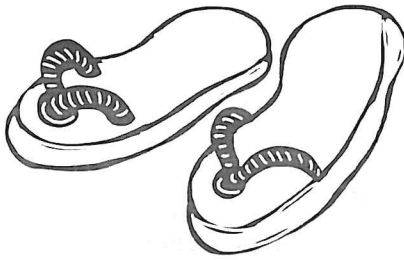

- slan
- slep
- slòf
- sleip



- plak
- plùk
- plat
- plas

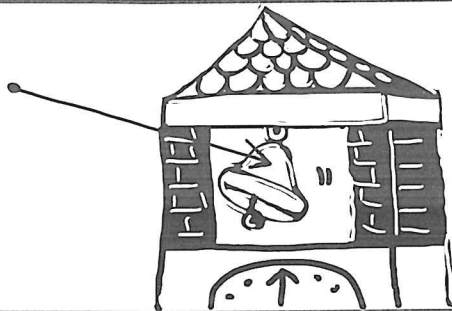

- klas
- klap
- klòk
- klei



- vlòt
- vlam
- vlui

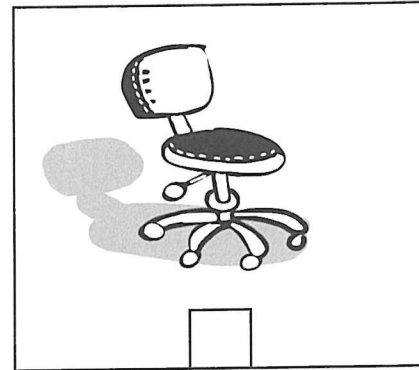
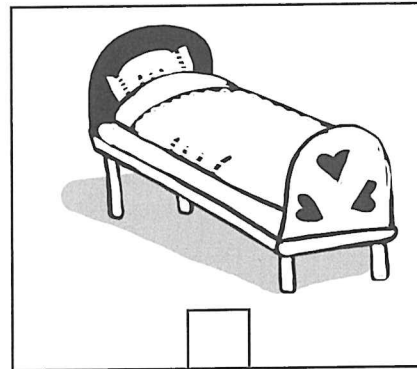
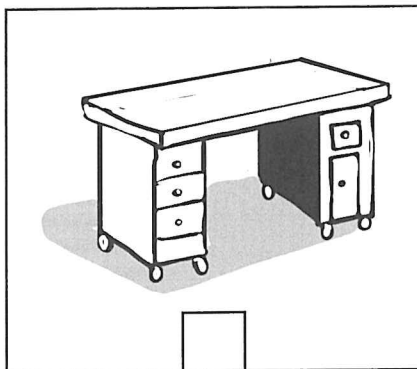
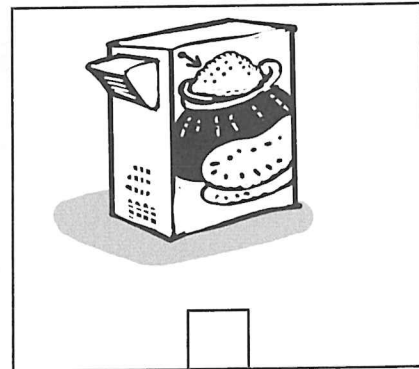
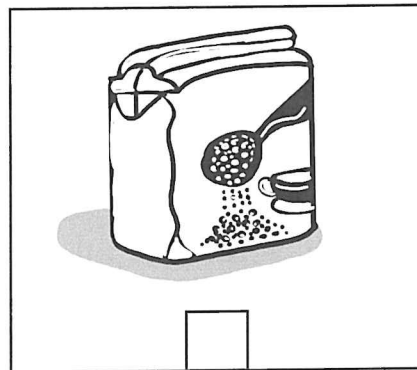
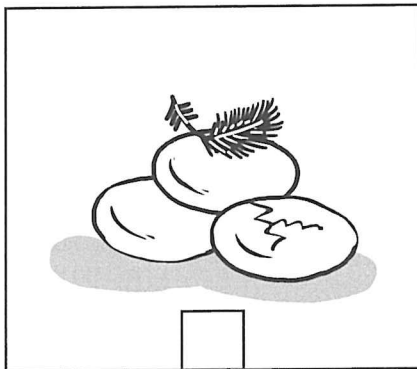
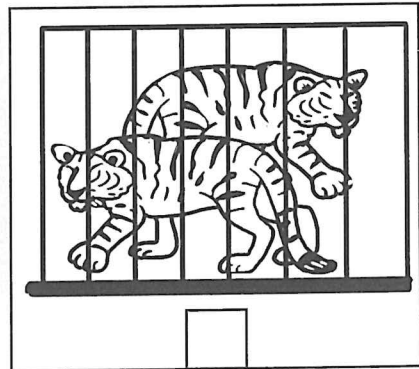
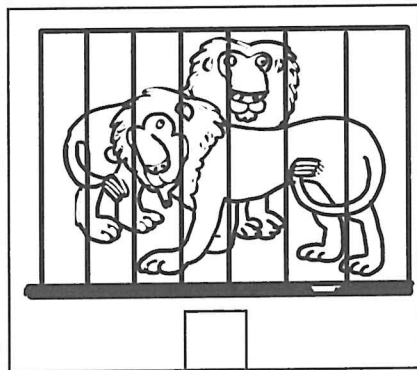
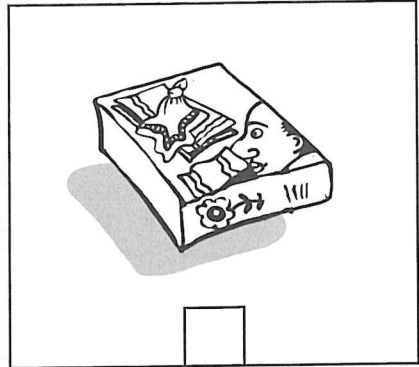
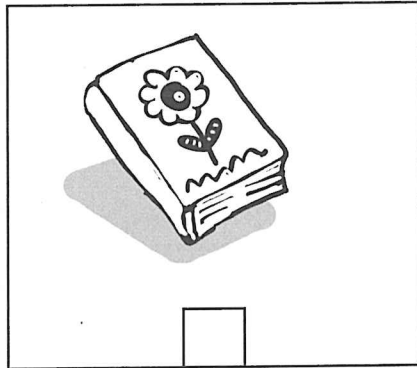
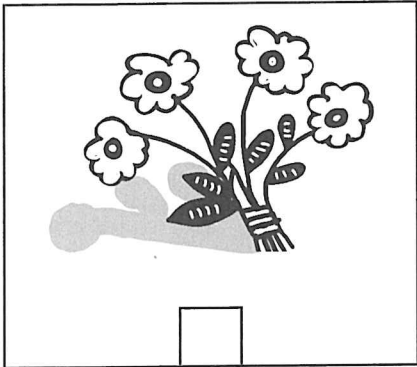





pòst pòst pòst pòst pòst pòst

pòst pòst pòst pòst pòst pòst